



Detection Supplies

Issue 17

Your one stop shop
for Fire Alarm and
Ancillary Equipment.



Addressable & Conventional Fire Products

MAGfire®

FLK2P



MAGISORP



PSD2



MAGPRO96G



ESP

••••• ScolmoreGROUP

Emergency Lighting

duceri®

EMDLED3WMBULK2



EMST3WMSDL



EM9WNMSPOT



EM3WNMDLK

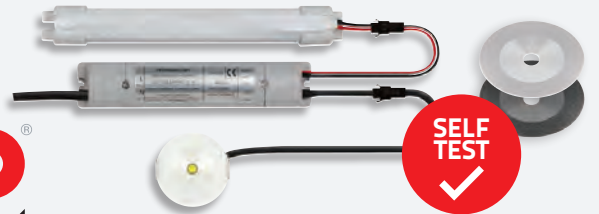

Fire Design Services

Commissioning

BAFE and FIA Accreditation



Product Training & Technical Team Support



Wiring Tutorials • Panel Configuration • Panel Operations
Device Setup • BS5839-1 British Standard Overview

Welcome to issue 17, our first unpriced edition of the Detection Supplies catalogue. For prices either speak to your account manager or go to our website for trade price lists.

As always Detection Supplies continues to look for new innovative manufacturers to partner with. In this issue we have added ESP to the mix. ESP have an excellent range of Emergency Lighting in addition to their range of both conventional and addressable fire detection options and also access control, CCTV and security. Speak to one of our team for more details.

The new Morley Max panel can be found on page 32.

The new Haes addressable panel on page 40.

A reminder that this is only a small selection of what we can offer, so please call us if you can't find what you are looking for.

Tel 01425 658239

Fax 01425 658241

Email sales@detectionsupplies.co.uk

Website www.detectionsupplies.co.uk

Our team has years of industry experience, making us ideally situated to answer your questions and provide you with advice on application and solution requirements. Renowned for our service offering, we can offer next day carriage paid deliveries on orders over £250. We also provide timed and third party delivery.

We would like to thank you for your continued support and look forward to working with you in the future.

Detection Supplies

Your one-stop-shop for Fire Alarm and Ancillary Equipment

CONVENTIONAL FIRE ALARM SYSTEMS 4-13

OPTICAL BEAM DETECTION, LINEAR HEAT
& ASPIRATING SYSTEMS 14-20

CONVENTIONAL TWO WIRE ALARM SYSTEMS 21-23

WIRELESS FIRE ALARM SYSTEMS &
TEMPORARY SITE ALARMS 24-27

ANALOGUE/ADDRESSABLE ALARM SYSTEMS 28-43

BATTERIES & POWER SUPPLIES 44-47

MAGNETIC DOOR RETAINERS & LOCKS 48-50

MAINS & HAZARDOUS AREA EQUIPMENT 51

TEST EQUIPMENT & LADDERS 52-54

FIRE EXTINGUISHERS & FIRE BLANKETS 55

PROTECTIVE CAGES & COVERS 56

DOMESTIC DETECTION EQUIPMENT 57

CALL SYSTEMS, INDUCTION LOOPS & EVC'S 58-59

SUNDRIES (CABLE, ZONE PLANS, LOG BOOK,
DOC BOX, TIMERS, CABLE REEL SEALANT & FOAM) 60-61

WATER LEAK DETECTION 62

AUTOMATIC OPENING VENT SYSTEMS 63

EMERGENCY LIGHTING & SIGNS 64-66

CONVENTIONAL FIRE ALARM PANELS

Conventional fire alarm panels are suitable for what are commonly referred to as 4-wire systems, i.e. detectors and call points wired on 2 cores per zone, with sounders and beacons wired on separate pairs. It should be noted that panels come with a varying number of sounder circuits, it does not follow that a 4 zone panel will always come with 4 sounder circuits. These panels are compatible with detectors shown on page 6 & 7.

C-TEC CFP



CFP704-4

- Dimensions W380 x H235 x D96mm
- LPCB Certified EN54
- Max alarm load 1.3A
- Max battery size 2 x 3.2Ah

CFP STANDARD PANELS (Requires up to 2 x 3.2ah Batteries)

CFP702-4	Standard 2 Zone Fire Alarm Panel with Keyswitch or Keypad Access Enable
CFP704-4	Standard 4 Zone Fire Alarm Panel with Keyswitch or Keypad Access Enable
CFP708-4	Standard 8 Zone Fire Alarm Panel with Keyswitch or Keypad Access Enable

CFP STANDARD PANEL OPTIONS

CFP760	Repeater Panel with Keyswitch or Keypad Access Enable
CFP761	Network Communications Card for CFP760

GLOBAL FIRE EQUIPMENT



ORION-8

- Dimensions W273 x H404 x D107mm
- EN54 Compliant
- Max alarm load 1.6A
- Max battery size 2 x 7Ah

ORION PANELS (Requires 2 x 7Ah Batteries) - available in White and Red

ORION-2	Orion 2 Zone Conventional
ORION-4	Orion 4 Zone Conventional
ORION-8	Orion 8 Zone Conventional

ESP



MAG4P

- Dimensions W340 x H290 x D100mm
- EN54 Compliant
- Max alarm load 0.7A
- Max battery size 1 x 7Ah

MAGFIRE PANELS

MAG2P	2 Zone Fire Alarm Panel
MAG4P	4 Zone Fire Alarm Panel
MAG816	8 Zone fire Alarm Panel Expandable to 16 Zones

MORLEY - IAS



FIRE RETARDANT ABS MOULDED ENCLOSURE

- Dimensions: W356 x H318 x D92mm
- 1.8 Amp PSU, 2 Sounder Circuits
- Maximum alarm load: 1.0 Amp
- Maximum battery size: 2 x 7Ah

MORLEY - IAS (Requires 2 x 7Ah Batteries)

HRZ-2E	002-492-222	2 Zone Fire Alarm Control Panel. 2 Detection Zones, 2 Sounder Outputs, Surface Mounting, Fire and Fault Relays.
HRZ-4E	002-492-242	4 Zone Fire Alarm Control Panel. 4 Detection Zones, 2 Sounder Outputs, Surface Mounting, Fire and Fault Relays.
HRZ-8E	002-492-282	8 Zone Fire Alarm Control Panel. 8 Detection Zones, 2 Sounder Outputs, Surface Mounting, Fire and Fault Relays.

OPTIONS & SPARES

020-772	4 Way Sounder Output Card (1.5A max)
020-747	8 Way Input / Output Card. Provides up to 8 Configurable Relay Outputs or up to 4 Inputs and 4 Outputs.
020-745-008	Spare Installation Kit 8 Capacitor EOL, Battery Lead, Allen Key, Panel Control Key and Sounders EOL Resistors.
020-417	Active End Of Line Kit For Panels
020-865	Spare Red Controls Key (Pack of 10)

HAES TECHNOLOGIES

ECLIPSE PANELS (Requires 2 x 3.2Ah Batteries)

ECL-2	Eclipse 2 Zone Fire Alarm Panel, 4 Wire or Sav-Wire
ECL-4	Eclipse 4 Zone Fire Alarm Panel, 4 Wire or Sav-Wire

ECLIPSE SPARES

FMK-ECL	Eclipse 2 & 4 Zone Recessing Bezel
---------	------------------------------------

EXCEL PANELS (Requires 2 x 7Ah Batteries)

XLEN-4	Excel 4 Zone Fire Alarm Panel 4 Wire or Sav-Wire
XLEN-6	Excel 6 Zone Fire Alarm Panel 4 Wire or Sav-Wire
XLEN-8	Excel 8 Zone Fire Alarm Panel 4 Wire or Sav-Wire
XLEN-12	Excel 12 Zone Fire Alarm Panel 4 Wire or Sav-Wire
XLEN-R12	Excel 2-12 Zone Fully Functional Repeater Panel

EXCEL SPARES

FMK-XLEN	Excel 4-12 Recessing Bezel for Excel 4-12 Zone Panel
KEY134	134 Key for Panel (x2)



ECLIPSE 2 & 4 ZONE CONVENTIONAL

- 4 Wire or Sav-Wire, switchable 2 wire option
- 1 amp power supply, fire & fault relays
- Maximum battery size: 2 x 3.2Ah
- Dimensions: W308 x H260 x D80mm
- 2 sounder circuits

EXCEL 4-12 ZONE (EXPANDABLE) CONVENTIONAL

- 4 wire or Sav-Wire, switchable 2 wire option
- 3 Amp power supply, fire & fault relays
- Maximum battery size: 2 x 7Ah
- Dimensions: W460 x H310 x D85mm
- 4 zone = 2 sounder circuits, 6 & 8 Zone = 4 Sounder circuits, 12 Zone = 6 Sounder circuits.

KENTEC

SIGMA PANELS WITH LCMU (Requires 2 x 3.2Ah Batteries)

KL11020M2	Kentec Sigma 2 Zone Surface Fire Alarm with Line Continuity Modules
KL11040M2	Kentec Sigma 4 Zone Surface Fire Alarm with Line Continuity Modules
KL11080M2	Kentec Sigma 8 Zone Surface Fire Alarm with Line Continuity Modules

SIGMA REPEATER PANELS

E01020L2	Kentec 2 Zone Surface Repeater Panel 24VDC
E01040L2	Kentec 4 Zone Surface Repeater Panel 24V DC
E01080L2	Kentec 8 Zone Surface Repeater Panel 24V DC

OPTIONS & SPARES

K14060	Kentec LCMU Line Continuity Module
K461	8 Way Sounder Card for Sigma Panel
S005	Kentec Spare Key Set (5 keys, 1x CAT30 1x 801, 1x 901, 1 x FH001 & 1 X KT3001)
M2FCLGT	Bezel for Semi Flushing Panel



METAL ENCLOSURE, KEYSWITCH ACCESS ENABLE

- Dimensions: W385 x H310 x D90mm
- PSU 3 Amp, 2 sounder circuits
- Changeover volt free fire & fault outputs
- Maximum battery size: 2 x 7Ah

FIRE ALARM ANCILLARIES

MAINS FIRE ALARM SPUR/ISOLATOR

A	T2-FAI	Fire Alarm Panel Mains Isolator, Red c/w Back Box
	FAIS-R-B	Fire Alarm Panel Mains Isolator, Red c/w Back Box
	T2-FAI-W	Fire Alarm Panel Mains Isolator, White c/w Back Box

MAINS FILTER

230MSF	3A Fused Mains Spike Filter
--------	-----------------------------

AUXILIARY RELAYS, BOXED

B	T2-TR-KS	5 Amp Isolatable Timer Relay, 24V Coil with Keyswitch and Back Box
C	503-003	5 Amp Metal Boxed Auxiliary Relay, 24V Coil
	REBOX24-10	8 Amp, IP55 Boxed Auxiliary Relay, 24V

AUXILIARY RELAY PCBs

D	AUX-R24PCB	5 Amp 24V DC Coil Double Pole Aux Relay
	AUX-R12PCB	5 Amp 12V DC Coil Double Pole Aux Relay
	AUX-BB	Plexo Box for Auxiliary Relay, Dimensions: 105 x 105 x 55

RELAYS ON SINGLE GANG PLATE

E	AUX-RIU-R24B	5 Amp Auxiliary Relay 24V Coil on Single Gang Plate
	BF376	5 Amp Auxiliary Relay 24V Coil on Single Gang Plate
	AUX-RIU-R12B	5 Amp Auxiliary Relay 12V Coil on Single Gang Plate

DETECTOR REMOTE INDICATORS

F	RIU-02	Detector Remote Indicator, on Flush ABS Plate
	RIU-02BB	Surface Mount Box for RIU-02
G	53832-070APO	Apollo Mini Disc Remote Indicator
	10-2011WFR-S	Remote Indicator Flush
	10-2011WSR-S	Remote Indicator with BB

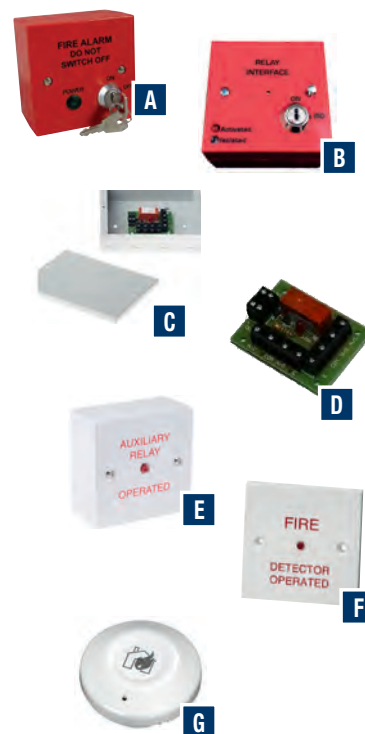

All product specifications are supplied by the manufacturer. All manufacturers reserve the right to change specification without notification.

APOLLO SERIES 65





SMOKE DETECTORS

- | | | |
|----------|--------------|----------------------------------|
| A | 55000-317APO | Series 65 Optical Smoke Detector |
|----------|--------------|----------------------------------|

HEAT DETECTORS

- | | | |
|----------|--------------|--|
| B | 55000-122APO | Series 65 Rate Of Rise Heat Detector A1R 57c |
| | 55000-127APO | Series 65 Rate Of Rise Heat Detector BR 75c |
| | 55000-132APO | Series 65 Rate Of Rise Heat Detector CR 90c |
| | 55000-137APO | Series 65 Fixed Temperature Heat Detector CS 90c |

FLAME DETECTORS

- | | | |
|----------|--------------|--|
| C | 55000-025APO | Series 65 Base Mounted UV Flame Detector |
|----------|--------------|--|

DETECTOR BASES

- | | | |
|----------|--------------|-----------------------------------|
| D | 45681-201APO | Series 65 Detector Base c/w Diode |
| | 45681-206APO | Series 65 Sav-Wire Detector Base |
| | 45681-245APO | Series 65 Standard Relay Base |
| | 45681-508APO | Series 65 12V Relay Base |
| E | 45681-204APO | Series 65 Plastic Conduit Box |

APOLLO ORBIS



Quicker and easier installations and servicing.

Improved false alarm rejection.

Variety of detectors for fast accurate fire detection in different environments



SMOKE DETECTORS

- | | | |
|----------|------------------|--------------------------------------|
| F | ORB-OP-12001-APO | Orbis Optical Smoke Detector |
| G | ORB-OH-13001-APO | Orbis Optical Smoke/Heat Multisensor |

HEAT DETECTORS

- | | | |
|----------|------------------|---|
| | ORB-HT-11001-APO | Orbis Rate Of Rise Heat Detector A1R 57c |
| | ORB-HT-11002-APO | Orbis Fixed Temperature Heat Detector A2S 57c |
| | ORB-HT-11003-APO | Orbis Rate Of Rise Heat Detector BR 75c |
| | ORB-HT-11004-APO | Orbis Fixed Temperature Heat Detector BS 75c |
| H | ORB-HT-11005-APO | Orbis Rate Of Rise Heat Detector CR 90c |
| | ORB-HT-11006-APO | Orbis Fixed Temperature Heat Detector CS 90c |

DETECTOR BASES

- | | | |
|--|------------------|---|
| | ORB-DB-00003-APO | Orbis TimeSaver Detector Base c/w Diode |
| | ORB-SW-10005-APO | Orbis TimeSaver Sav-Wire Base |
| | ORB-RB-10004-APO | Orbis TimeSaver Relay Base |

DUCT HOUSING

- | | | |
|--|--------------|---|
| | 53546-023APO | Orbis Duct Detector Housing (Requires ORB-OP12001APO) |
|--|--------------|---|

C-TEC ACTIV





C-TEC C4416 ACTIV OPTICAL SMOKE DETECTOR

- Dimensions 102 diameter x D57mm
- Intertek Certified EN54
- 9-33V DC operating voltage
- 360° LED visibility when activated



SMOKE DETECTORS

- | | | |
|----------|-------|--------------------------------------|
| I | C4416 | ActiV Optical Smoke Detector |
| | C4414 | ActiV Optical Smoke/Heat Multisensor |

HEAT DETECTORS

- | | | |
|----------|----------|--|
| | C4403A2 | ActiV Heat Detector Class A2 Fixed Temperature 60c |
| J | C4403B | ActiV Heat Detector Class B Fixed Temperature 75c |
| | C4403A1R | ActiV Heat Detector Class A1R Rate Of Rise |

DETECTOR BASES

- | | | |
|--|--------|-------------------------------|
| | C4408D | ActiV Detector Base c/w Diode |
| | C4408R | ActiV Relay Detector Base |

SOUNDERS/VAD

- | | | |
|--|-----------------|--|
| | BF456C/CC/W | ActiV Conventional C-3-8.5 Base VAD c/w 96dB(A) Sounder |
| | BF432C/CC/W | ActiV Conventional O-R-3-2.5-17 Base VAD c/w 96dB(A) Sounder, ideal for corridor use |
| | BF431C/CC/W | ActiV 96dB(A) Conventional Base Sounder |
| | BF433C/CC/SR | ActiV Conventional Hi-Output W-2.75-9 Wall VAD c/w 100dB(A) Sounder (shallow base) |
| | BF430C/CC/SR | ActiV Conventional Hi-Output 100dB(A) Wall Sounder (shallow base) |
| | BF430C/CC/DR/65 | ActiV Conventional Weatherproof Hi-Output 100dB(A) Wall Sounder (IP55) |
| | BF433C/CC/DR | ActiV Conventional Hi-Output W-2.75-9 Wall VAD c/w 100dB(A) Sounder (deep base) |
| | BF430C/CC/DR | ActiV Conventional Hi-Output 100dB(A) Wall Sounder (deep base) |
| | BF433C/CC/DR/65 | ActiV Conventional Weatherproof Hi-O/P W-2.75-9 Wall VAD c/w 100dB(A) Sounder (IP55) |

NITTAN EVOLUTION

SMOKE DETECTORS

- A** EVC-P Conventional Photoelectric Detector c/w 375 Ohm Resistor
- EVC-DP Conventional Dual Photoelectric Detector c/w 375 Ohm Resistor

HEAT DETECTORS

- B** EVC-H-A2 Conventional Heat Detector 54-70 DEG. c/w 375 Ohm Resistor
- EVC-H-CS Conventional Heat Detector 84-100 DEG. c/w 375 Ohm Resistor

FLAME DETECTOR

- EVC-IR Conventional Dual Band IR Flame Detector c/w 375 Ohm Resistor

DETECTOR BASE

- UB-6-EV Universal Base - Use with EV Conventional Detectors



MORLEY-IAS VISION

SMOKE DETECTORS

- C** 2020P Optical Conventional Detector.
- 2020PT Optical Thermal Multi Criteria Conventional Detector.

HEAT DETECTORS

- D** 2020HF High Fixed Temperature Thermal BS (78°C) Conventional Detector
- 2020R Rate of Rise Thermal A1R (58°C) Conventional Detector
- 2020F Fixed Temperature Thermal A2S (58°C) Conventional Detector

DETECTOR BASES

- 2020BSD Detector Mounting Base fitted with Schottky Diode
- 2020B Standard Detector Mounting Base



HOCHIKI CDX

SMOKE DETECTORS

- E** SOC-E3N Photoelectric Smoke Detector

HEAT DETECTORS

- F** DFJ-AE3 Fixed Temperature Heat Detector A1-A1S 60c
- DFJ-CE3 Fixed Temperature Heat Detector C-CS 90c
- DCD-AE3 Combined Heat Detector A1-A1R 60c
- DCD-CE3 Combined Heat Detector C-CR 90c
- DFG-60BLKJ IP67 Waterproof Fixed Temperature Heat Detector 60c c/w Integral Base

FLAME DETECTORS

- DRD-E Infra Red Flame Detector

DETECTOR BASES

- YBN-R/6SK Shottky Diode Detector Base
- YBN-R/6 Detector Base
- YBO-R/6PA Sav-Wire Detector Base
- YBO-R/6R Latching Relay Base
- YBO-R/6RN Non Latching Relay Base
- YBO-R/6RS Latching Relay & Diode Base

OPTICAL BEAM DETECTOR

- G** SPC-ET Beam Detector 5-100 Metres Transmitter & Receiver Set



(Devices also available in White by adding WHT to the end of the part number)

GLOBAL FIRE EQUIPMENT

ZEOS CONVENTIONAL DETECTORS

- H** ZEOS-C-S ZEOS Conventional Smoke Detector
- ZEOS-C-H ZEOS Conventional Heat Detector
- ZEOS-C-SH ZEOS Conventional Multisensor
- ZEOS-BASE ZEOS Detector Base



All product specifications are supplied by the manufacturer. All manufacturers reserve the right to change specification without notification.

FIRE ALARM CALL POINTS

Resettable MCP single pole changeover contacts. Mimics the feel of breaking glass whilst offering the user the benefits and environmental advantages of a resettable operating element. Once activated a flag drops into view. Simply reset with a key and the MCP is ready for re-use straight away. Alternative electrical arrangements and colours available within this range.

STI CALL POINTS



OTHER COLOURS
AVAILABLE



A

STI CALL POINTS

	RP-BD2-11	Blue Dual Mount (Flush or Surface) Resettable Call point, Double Pole Changeover
A	RP-RD2-01	Red Dual Mount (Flush or Surface) Resettable Call Point 470 or 680 Ohm EN54-11
	RP-YD2-02	Yellow Dual Mount (Flush or Surface) Resettable Call Point, Single Pole Changeover
	STI-CI	Hinged Call Point Cover
	ST-M210	Spare Key for STI Call Points (per 1)

KAC CALL POINTS



B



C



D



E



F

FIRE ALARM CALL POINTS

	M1A-R470SG-STCK	Red Surface Call Point 470 Ohm
	M1B-R470SG-STK01	Red Sav-Wire Surface Call Point
	M1A-R470SF-STCK	Red Resettable Surface Call Point 470 Ohm
	M1A-R470SGK01381	Red Intrinsically Safe Surface Call Point 470 Ohm

WEATHERPROOF CALL POINTS

B	W1A-R470SGSTCK01	Red IP67 Call Point 470 Ohm
	WCP1B-R470SF01	Red IP67 Resettable Sav-Wire Call Point
	W3A-G000SGSTCK12	Green IP67 Call Point (No Resistor)

OTHER CALL POINTS

	M8A-G000SF	Green Resettable Element Call Point, Triple Pole, Surface
	M8A-G000SG	Green Breakglass Call Point, Triple Pole, Surface
	MCP3A-R000SG01	Red Surface Call Point (No Resistor)
	M3A-R000SFSTCK01	Red Resettable Surface Call Point (No Resistor)
C	M3A-G000SGSTCK12	Green Emergency Door Release Surface Call Point
	MCP3A-G000SFSTCK12	Green Resettable Emergency Door Surface Release Call Point
	M4A-G000SFSTCK12	Green Double Pole Resettable Call Point
	M3A-Y000SGSTCK11	Yellow Surface Call Point (No Resistor)
D	M3A-A000SG01	Orange Vent Release Surface Call Point (No Resistor)
	M3A-B000SGK01311	Blue Surface Call Point (No Resistor)

KEYSWITCH CALL POINTS

	K20SR5-01	Red 2 Position Keyswitch Call Point, Key Removable In All Positions
	K20SYS-11	Yellow 2 Position Keyswitch Call Point, Key Removable In All Positions
	K21SGS-12	Green Emergency Door Release Keyswitch Call Point, Key Trapped
	K21SR5-01	Red 2 Position Keyswitch Call Point, Key Trapped
	K20SAS-11	Orange 2 Position Keyswitch Call Point, Removable In All Positions
	K21SWS-11	White 2 Position Keyswitch Call Point, Key Trapped
E	K30SR5-43	Red 3 Position Fireman's Vent Extract Switch, Key Removable In All Positions
F	K30SYS-33	Yellow 3 Position Fireman's Vent Extract Switch, Key Removable In All Positions

SPARES & ACCESSORIES

	MUS156	KG1-10 Spare Glass for KAC Call Point 76mm x 40mm (Per 10)
	SC070	Spare Key for KAC Call Points (Per 10)
	SC061	Spare Key for KAC Resettable Call Point (Per 10) Old Style
	PS200	Hinged Call Point Cover
	PS210	Flexible Operating Element
	SC086	Spare Key for 2 Position Keyswitch Call Point A126 Key (Per 1)
	SC087	Spare Key for 3 Position Keyswitch Call Point 603 Key (Per 1)

All product specifications are supplied by the manufacturer. All manufacturers reserve the right to change specification without notification.

EATON CALL POINTS

FIRE ALARM CALL POINTS

A	CXL-UNIV-R	Red Universal Call Point with LED 470 or 680 Ohm
	CXL-GP-R-IP	Red Call Point IP66 with LED 470 or 680 Ohm

CALL POINTS WITH 240V RATED CONTACTS

	CXM-CO-GP-R-BB	Red Call Point 240V Changeover Contacts
B	CXM-CO-G-Y-BB	Yellow Call Point 240V Changeover Contacts
	CXM-CO-G-R-WP	Red Call Point 240V Changeover Contacts IP66

SPARES & ACCESSORIES

C	CX-KEY	Spare Key for Fulleon Call Points (Per 10)
	CXS-G	Spare Glass for Fulleon Call Points (Per 10)
	CXS-PC	Perspex Call Point Cover
	CX-R-KIT	Resettable Element Conversion Kit (Per 10)



EATON SOUNDERS & BEACONS

Please note: Part numbers and prices shown are without bases. Photos show sounders with bases fitted for illustration purposes. Please order the appropriate bases from the "Standard Bases" section shown below.



SOUNDERS

D	ROLP-SV-R-3	Roshni Red Sounder 9-28V DC 12mA 102dB (No Base)
E	ROLP-SV-W-NB	Roshni White Sounder 9-28V DC 12mA 102dB (No Base)

SOUNDER/LED BEACONS

F	ROLPSB-SV-RL-R-N	Roshni Red Sounder/LED Beacon 18-28V DC 21mA 102 dB (No Base)
	ROLPSB-RL-W-S	Roshni White Sounder/LED Beacon with Red Lens (No Base)

SOUNDER/XENON BEACONS

G	FL-RL-R-NB	Flashni Red Sounder Beacon 18-28V DC 70mA 90dB (No Base)
H	FL-AL-W-N-SEP-SW	Flashni White Sounder Beacon 18-28V DC with Amber Lens (No Base)
	FL-RL-WD-SEP-SW	Flashni White Sounder Beacon 18-28V DC with Red Lens (No Base)

XENON WALL BEACONS

I	SO-R-NB-3C	Solex Red Beacon 10-60V DC 25mA (No Base)
	SO-C-SW-3C	Solex Clear Beacon 10-60V DC 25mA (No Base)
	SO-G-SW-3C	Solex Green Beacon 10-60V DC 25mA (No Base)
	SO-A-NB-3C	Solex Amber Beacon 10-60V DC 25mA (No Base)

LED CEILING BEACONS

J	SOL-RL-R-NB	Solista Red Ceiling Beacon 10-30V DC 3-6mA (No Base)
	SOL-RL-W-NB	Solista White Ceiling Beacon with Red Lens (No Base)

STANDARD BASES

K	SR01	Red Shallow Base
L	DR01	Red Deep Base IP65
	UR01	Red 'U' Base IP65
	SW01	White Shallow Base
	DW01	White Deep Base IP65
	UW01	White 'U' Base IP65

MAINS CONVERSION MODULE BASES (Converts 24V DC Devices to 240V AC mains power Units)

	DRB240V	Red Mains Conversion Module Base
	DWB240V	White Mains Conversion Module Base



All product specifications are supplied by the manufacturer. All manufacturers reserve the right to change specification without notification.

We make safe and sound work.*



* The world's no.1 supplier for fire notification devices.¹

With our diverse portfolio including Cooper, Fullcon, JSB and Menvier, alongside our ATEX explosion-proof products from MEDC and UL certified sounders from Wheelock, it means approximately **1 in 5 of every Fire Notification device installed is an Eaton product.**

EATON

Powering Business Worldwide

Protect your people, property and assets

Notification in event of an emergency, such as a fire, is paramount to ensure the safe evacuation of people from the premises.

Eaton is a leading manufacturer of fire alarm devices designed to protect what matters most.

Visit www.eaton.com/gb to find out more.

¹ Source: IHS Markit Report – 2018

EN54-23 is the latest standard for Visual Alarm Devices (VADs) where visual alarm is required to reinforce or replace audible alarms. Typical application:-

- Warning for those with hearing impairments
- Operating theatres
- Recording studios
- Where a staff alert only signal is required
- Areas with high background noise
- Please note – if VADs are required, an illumination of not less than 0.4 Lux must be achieved at floor level.

EATON

WALL VADS

- A** SOL-LX-W-RF-R1-S Solista Red Wall VAD, with Shallow Base 9-60V DC 10-25mA EN54-23
- SOL-LX-W-RF-R1-D Solista Red Wall VAD, with Deep IP65 Base 9-60V 10-25mA EN54-23

CEILING VAD

- B** SOL-LX-C-RF-W1-S Solista White Ceiling VAD, with Red Flash & Shallow Base 9-60V 10-25mA EN54-23

VAD SOUNDERS

- ROLPBASE-LX-W-RF-R1 Red VAD Base 18-28V 28mA EN54-23 (Requires Roshni Sounder)
- SYG1-LX-W-RF-R1 Symphoni Red VAD Sounder, with Base 18-28V 30mA 100dB EN54-23

- C** SYG1-LX-W-RF-R1-WP Symphoni Red VAD Sounder, with IP66 Base 18-28V 30mA 100dB EN54-23

SOUNDER VAD BASE (Image shown with SQ-Cover-W, supplied separately)

- D** SQ-G3-23/W1/WF Squashni VAD Base Sounder with White Flash EN54-23

SQUASHNI PLATFORM SOUNDER

- E** SQ-SV-S-W Squashni Sounder White 28 Tone 10-28V DC 18mA 93dB

- SQ-COVER-R Squashni Red Cover Plate

- SQ-COVER-W Squashni White Cover Plate

SQUASHNI MICRO LOW CURRENT PLATFORM SOUNDER

- SQM-W Squashni Micro White Sounder 9-30V DC 5mA 95dB

- SQM-COVER-W Squashni Micro White Cover Plate, for SQM-W

SQUASHNI MICRO SOUNDER BEACON

- SQMSB-RL-W Squashni Micro Sounder with Solista Beacon 15-30V DC 3-10mA 97dB

ASKARI BEDHEAD SOUNDERS

- F** AC-R3 Askari Red Flush Sounder 9-28V DC 18mA 97dB

- BB-R Askari Red Surface Box

- AC-W3 Askari White Flush Sounder 9-28V DC 18mA 97dB

- BB-W Askari White Surface Box

SYMPHONI SOUNDERS

- SY-R Symphoni Red Sounder 18-30V DC 5mA 100dB

- SY-W Symphoni White Sounder 18-30V DC 5mA 100dB

- G** SY-IP-R Symphoni Red Sounder IP65 18-30V DC 5mA 100dB

- SY-IP-HO-R Symphoni Red High Output Sounder IP65 18-28V DC 240mA 120dB

CENTRIFUGAL BELL

- H** CFB6D24 Bell 6" Red 20-28V DC 25mA 95dB

ELECTRONIC BELLS

- I** FB024 Bell 6" Red 24V DC 35mA 95dB

- FB024-G Bell 6" Grey 24V DC 35mA 95dB

IP55 ELECTRONIC BELLS

- FB024-WP

- FB024-G-WP Bell 6" Grey Weatherproof IP55 24V DC 35mA 95dB

- FB-WP-KIT Weatherproof Bell Kit



The Squashni range can be ceiling mounted as a platform for a smoke or heat detector, or if fitted with a cover plate, it can be used on either a wall or ceiling.

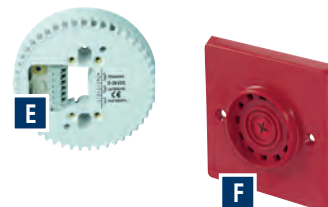

GLOBAL FIRE EQUIPMENT

VULCAN 2 CONVENTIONAL SOUNDER BASES

- J** VULCAN2-CS Vulcan 2 Conventional Base Sounder c/w Lid

- VULCAN2-CB Vulcan 2 Conventional Base Beacon c/w Lid

- VULCAN2-CSB Vulcan 2 Conventional Base Sounder Beacon c/w Lid

- CALL POINTS

- GFE-MCPE-C GFE Conventional Manual Call Point, Red c/w Cover



VIMPEX



BANSHEE SOUNDER

	902CHA6AO	Banshee Excel Red Wall Sounder with Shallow Base
A	903CHA6AO	Banshee Excel Red Wall Sounder with IP66 Base
B	902CHA4AO	Banshee Excel White Wall Sounder with Shallow Base
	903CHA4AO	Banshee Excel White Wall Sounder with IP66 Base

BANSHEE PLATFORM SOUNDER

C	IDBTS-W	Banshee Excel White Sounder Base
---	---------	----------------------------------

BANSHEE SOUNDER BEACONS

	958CHL1000	Banshee Excel Red Wall Sounder/LED Beacon with Shallow Base
	958CHL1001	Banshee Excel Red Wall Sounder/LED Beacon with IP66 Base
	958CHX1000	Banshee Excel Red Wall Sounder/Xenon Beacon with Shallow Base
	958CHX1001	Banshee Excel Red Wall Sounder/Xenon Beacon with IP66 Base

LOW FREQUENCY SOUNDER (FOR ANIMAL LABORATORIES/KENNELS ETC.)

D	ANI-S	Ani-Mate Low Frequency Animal Friendly Sounder
---	-------	--

FIRE CRYER SOLO (SINGLE MESSAGE VOICE SOUNDERS)

E	FCS/A/R/O/D	Fire-Cryer SOLO Standard - Red (D/B) IP66,, EN54-3
	FCS/A/R/O/S	Fire-Cryer SOLO Standard - Red, EN54-3
	FCS/A/R/R/D	Fire-Cryer SOLO Single Msg, Red, Red beacon, D/B, EN54-3
	FCS/A/R/R/S	Fire-Cryer SOLO Single Msg, Red, Red Beacon, S/B, EN54-3
F	FCS/C/W	Mini Fire-Cryer SOLO, White, Base Mounted, EN54-3 (Detector not included)

Pre-Recorded Message preceded with a Banshee Alarm Tone -
"Fire emergency. Please remain calm and evacuate the building immediately".

CLAMBELL FIRE ALARM BELLS

G	CBE6-RS-024-EN	ClamBell 24V 6" Fire Alarm Bell, Shallow Base
	CBE6-RS-012-EN	ClamBell 12V 6" Fire Alarm Bell, Shallow Base
	CBE6-RD-230-EN	ClamBell 230V 6" Fire Alarm Bell, Deep Base

STROBELL COMBINED FIRE ALARM BELL AND VISUAL INDICATOR DEVICE

H	SBE6-RS-024-EN-RW	StroBell Combined Fire Alarm Bell, Red, 24V, Shallow Base
---	-------------------	---

VIMPEX



IDENTIFIRE TRITONE SOUNDERS

I	10-1010RFX-S	Identifire Tritone Sounder Flush Mount, Red, 98dB(A), 5mA, EN54-3
J	10-1010RSX-S	Identifire Tritone Sounder Surface Mount, Red, 98dB(A), 20-28V DC, 5mA, EN54-3
	10-1010WFX-S	Identifire Tritone Sounder Flush Mount, White, 98dB(A), 20-28 V DC, 5mA, EN54-3
	10-1010WSX-S	Identifire Tritone Sounder Surface Mount, White, 98dB(A), 20-28V DC, 5mA, EN54-3

IDENTIFIRE SOUNDER VID

K	10-1110RFR-S	Identifire Tritone Sounder VID Flush Mount, Red, 20-28V DC, 14mA, EN54-3
	10-1110RSR-S	Identifire Tritone Sounder VID Surface Mount, Red, 20-28V DC, 14mA, EN54-3

IDENTIFIRE VID

L	10-1310RSR-S	Identifire VID Surface Mount, Red, 12-28V DC, 8mA
M	10-1310WSR-S	Identifire VID Surface Mount, White, Red, 12-28V DC, 8mA

IDENTIFIRE PLATFORM SOUNDER

N	IDBTS-W	Identifire Base Sounder, White, Complete with cover, 32 Tones, 18-30V DC, 90dBA, EN 54-3
---	---------	--

CEILING VAD

O	CBE1002-C	Conventional Ceiling Mount VAD with Base, White, Flash C3-7.5
---	-----------	---

IDENTIFIRE REMOTE LAMP UNIT

	10-2011WFR-S	Identifire Remote Lamp Unit, Flush, White, Red
P	10-2011WSR-S	Identifire Remote Lamp Unit, Surface, White, Red
	10-2111WFR-S	Identifire Remote Lamp Unit with Buzzer, Flush, White, Red
	10-2111WSR-S	Identifire Remote Lamp Unit with Buzzer, Surface, White Red

All product specifications are supplied by the manufacturer. All manufacturers reserve the right to change specification without notification.

CRANFORD

VISUAL ALARM DEVICES VAD - EN54-23 APPROVED

- 512-306 Wall VAD Red Body, Red Flash with Deep Base IP65
- 512-308 Wall VAD Red Body, White Flash with Deep Base IP65

FIRE ALARM SOUNDER / VAD - EN54-23 & EN54-3 APPROVED

- A 511-306 Wall Sounder & VAD Red Body, Red Flash with Deep Base IP65
- 511-308 Wall Sounder & VAD Red Body, White Flash with Deep Base IP65

FIRE ALARM WALL SOUNDERS - EN54-3 APPROVED

- 510-019 Wall Sounder Red Body with Deep Base IP65
- 510-020 Wall Sounder White Body with Deep Base IP65

FIRE ALARM CEILING SOUNDERS - ACCEPTS DETECTOR BASES FROM ALL MAJOR MANUFACTURERS - EN54-3 APPROVED

- B 507-001 Low Profile Conventional Ceiling Sounder
- 509-001 Low Profile Conventional Ceiling Sounder & Beacons



AUDIBLE ONLY FIRE ALARMS ARE NOT ALWAYS SUFFICIENT- VISUAL ALARMS DEVICES (VADS) FOR THE HEARING IMPAIRED

- EN54-23 Approved
- Used anyway the Hearing Impaired Could be Isolated
- Used in Any Loud > 90dB (A) Environment
- Available in White or Red Flash & with Sounder Functionality



MAGFIRE

SOUNDERS

- BA-2R MAGfire Red Banshee Excel Sounder (87-112dba)
- C BA-2W MAGfire White Banshee Excel Sounder (87-112dba)
- MAGBSW MAGfire Bedhead White Sounder, Flush Mounted
- D MAGSRS MAGfire Red Sounder, Surface Mounted
- MAGSWS MAGfire White Sounder, Surface Mounted

SOUNDER + STROBE

- CB-1R MAGfire Combined Red Banshee Sounder + Strobe
- CB-1RIP66 MAGfire Red Banshee Sounder + Strobe IP66
- E MAGSSTRRS MAGfire Red Sounder + Strobe, Surface Mount
- MAGSSTRWS MAGfire White Sounder + Strobe, Surface Mount



All product specifications are supplied by the manufacturer. All manufacturers reserve the right to change specification without notification.

OPTICAL BEAM DETECTORS

Optical Beam Detectors are best suited to wide open areas such as warehouses and aircraft hangars, or where ceiling access, or construction will not support the installation of cables.

THE FIRE BEAM COMPANY

thefirebeam™

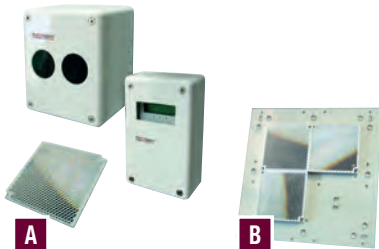

FIRE BEAM XTRA

A	FIREBEAM XTRA	Self Aligning Beam Detector 7-70 Metre
B	70KIT140	Range Extension Kit 70-140 Metre
	140KIT160	Range Extension Kit 140-160 Metre

ANTI FOG KITS

FIREBEAM XTRA-AF	Anti Fog Firebeam Xtra
WINDOW-AF	Anti Fog Window for Beam Head
REF-AF	Anti Fog Single Reflector
70KIT140AF	Anti Fog Range Extension Kit 70-140 Metre
140KIT160-AF	Anti Fog Range Extension Kit 140-160 Metre

BRACKETS

FB-BRACKET	Adjustable Wall Bracket for Firebeam or Single Reflector
------------	--

SPARES

TF	Obscuration Test Filter for Reflector Beam Detector
----	---

REFLECTORS	Single Reflector
------------	------------------

FIRE BEAM BLUE

FIREBEAM BLUE	Reflector Beam 7-70metre, inc 1 reflector
---------------	---



The firebeamBLUE uses the advanced theFireBeamXtra Technology, inherits the same reliability, benefits and an unbeatable range of 160 metres but is commissioned and controlled using the App.

STI



PROTECTIVE CAGES

	STI-9862	Steel Cage Protector for Fire Beam Controller H187 x W122 x D70mm
C	STI-9861	Steel Cage Protector for Fire Beam Head H186 x W160 x D143mm

Find full range of protective cages on page 56

thefirebeam™

Winner of the fire industry international awards for product innovation.....
thefirebeam is the ultimate optical beam detector available today, it has addressed all the problems you normally associate with this type of detection.

What makes thefirebeam so special ?

Its the first **motorised self aligning** reflective optical beam smoke detector to be launched onto the market...that after following a simple procedure will self align at installation, saving time, aggravation and the uncertainty of **misalignment**, all of which cost time and money. Once aligned **it will continually re-align itself against building movement**, saving time and the disruption of high level re-alignment and more importantly **reduces expensive false alarms** and will keep your reputation intact.

The low level controller means all beam settings can be changed and monitored at floor level (such as threshold and time to fire), no more climbing to the beam head to make adjustments. Using only 3mA in any state it is **possible to make thefirebeam addressable using a manufactures interface**, that in some cases can be zone powered. **Thefirebeam** with all its advanced features is being hailed as the industry favourite

"thefirebeam - a reliable effective alternative to air sampling and spot detection at considerably less cost"

Accessory range the standard firebeam comes with a low level controller and one reflector that covers a range of 7-70 metres. Longer distances can be achieved by using our range kits below.

Mid Range Kit
extends the range of your firebeam to 70/140 metres made from clear acrylic and pre-drilled with unistrut friendly holes



Long Range Kit
extends the range of your firebeam to 140/160 metres made from clear acrylic and pre-drilled with unistrut friendly holes

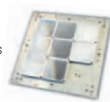

Adapter Plate
made from clear acrylic and pre-drilled with unistrut friendly holes you can fit either the head or single reflector to this

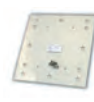

Anti Fog kits and Reflector
In some applications condensation can cause a problem, to solve this we have developed reflectors and lens covers that are specially coated and will not mist over. Available as a retro fit kit of lens and single reflector, or single reflectors



Visit the web site for latest information and technical details

www.thefirebeam.com



FFE

FIRERAY ONE

A	6010-100	Fireray One 1 Prism 50 Metre
	1010-000	Fireray Long Range Kit 3 Prisms 120 Metre
	1170-000	Mounting Bracket for Fireray One 360 Degree Rotation
	1060-000	Anti-Condensation Heater and Bracket for Fireray One
	1100-000	Protective Cage for Fireray One

FIRERAY 5000

B	5000-101	Fireray 5000 Beam Detector 50 Metre, 1 x TX & RX Head
C	5000-002	Fireray 5000 Additional Head & Prism 50 Metre (Max. 2 Per Beam)
	5000-005	Universal Bracket for FR5000 Head or Prism Plates
	5000-007	4 Way Prism Plate (Requires FR5000-005 Bracket)
	5000-008	Single Prism Plate (Requires FR5000-005 Bracket)
	5000-204	Anti-Condensation Heater and Bracket for FR5000 Detector or Head
	1000-018	Protective Cage for Fireray 5000 Motorised Detector
	1000-019	Protective Cage for Fireray 5000 System Controller

FIRERAY 3000

D	3000-101	Fireray 3000 Optical Beam Detector c/w Controller 5-120 Metre
E	3000-015	Fireray 3000 Additional Beam Detector Set 5-120 Metre
	3000-204	Anti-Condensation Heater and Bracket for FR3000 Trans/Rec or Trans

EXPLOSION PROOF

3000-115 Explosion Proof Beam Detector

ANTI-CONDENSATION HEATER

5000-205 Anti-Condensation Heater and Bracket for FR5000 Prism(s)

TEST FILTER

TF Obscuration Test Filter for Reflective Beam Detector



STI

PROTECTIVE CAGES

	STI-9624	Steel Cage Protector for Fireray 5000 Controller H225 x W140 x D120mm
F	STI-9840	Steel Cage Protector for Fireray 5000 Beam Transmitter Dia168 x D168mm



XTRALIS

IMAGERS

G	OSI-10	OSID 7 Degree Imager
	OSI-90	OSID 80 Degree Imager

EMITTERS

	OSE-SP-01	OSID Standard Battery Operated Emitter (Includes Battery)
	OSE-SPW	OSID Standard 24V DC Emitter
	OSE-HPW	OSID High Power 24V DC Emitter

INSTALLATION KIT

OSID-INST OSID Installation Kit - Includes Laser Alignment Tool, Test Filter, PC Cable, Cleaning Cloth & Manual

PROTECTIVE CAGE

H	OSID-WG	OSID Wire Guard
----------	---------	-----------------

OSID
by xtralis

- Superior smoke detection & nuisance alarm rejection
- Simple & fast installation, easy to align
- High tolerance to vibration & structural movement
- High immunity to dust, steam, birds & insects
- High resistance to reflections & sunlight

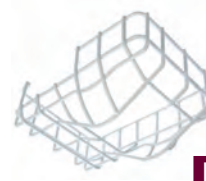

Please note: The X-OSI-10 Imager must be paired with either the X-OSE-SP or X-OSE-SPW standard power emitter. The X-OSI-10 can only support one emitter. The X-OSI-45 & X-OSI-90 Imagers are used in multi emitter applications, or in shorter distance applications. The appropriate number of emitters must be paired with the imager to a maximum number of seven.

Find full range of protective cages on page 56

All product specifications are supplied by the manufacturer. All manufacturers reserve the right to change specification without notification.

For more information or to place an order:

Phone: 01425 658239

Fax: 01425 658241

Email: sales@etectionsupplies.co.uk

ALARMLINE II DIGITAL CABLE

Alarmline II Digital sensor cables are a flexible, durable and cost-effective form of fire detection, suitable for protecting a wide range of commercial and industrial applications. They provide flexibility in installation, enabling them to be used for general area protection or proximity detection close to a specific point of risk. A wide range of alarm temperatures, protective coatings and installation fixings ensure system design and installation is specific to the risk. Alarmline II Digital sensor cables are especially suited for confined areas and harsh environmental conditions, which prohibit the use of other forms of detection. Alarmline II Digital sensor cables can be easily integrated to any fire control panel through a monitored input i.e. conventional detection zone, Zone Monitor Unit or Switch Monitor Unit. The Digital Location Control Unit provides additional functionality to the Alarmline II Digital sensor cable system by being able to determine the alarm location along extended lengths of digital sensor cable (up to 3000m).

ALARMLINE II DIGITAL CABLE

ALARMLINE II



A



B



C

68°C/88°C ALARM TEMPERATURE SENSOR CABLE - 100M (ALSO AVAILABLE 500M/1000M DRUMS) (100M/500M FOR STAINLESS STEEL)

A	AD68-0100	Digital Cable 68°C PVC - (PVC outer sheath)
B	AD68N-0100	Digital Cable 68°C Nylon - (Nylon outer sheath)
	AD68P-0100	Digital Cable 68°C Poly - (PVC coated cable with Polypropylene outer sheath)
C	AD68SS-0100	Digital Cable 68°C SS & PVC - (PVC coated cable with Stainless Steel outer braid)
	AD88-0100	Digital Cable 88°C PVC - (PVC outer sheath)
	AD88N-0100	Digital Cable 88°C Nylon - (Nylon outer sheath)
	AD88P-0100	Digital Cable 88°C Poly - (PVC coated cable with Polypropylene outer sheath)
	AD88SS-0100	Digital Cable 88°C SS & PVC - (PVC coated cable with Stainless Steel outer braid)

105°C/185°C ALARM TEMPERATURE SENSOR CABLE - 100M (ALSO AVAILABLE 500M/1000M DRUMS) (100M/500M FOR STAINLESS STEEL)

	AD105-0100	Digital Cable 105°C PVC
	AD105N-0100	Digital Cable 105°C Nylon
	AD105P-0100	Digital Cable 105°C Poly
	AD105SS-0100	Digital Cable 105°C SS & PVC
	AD185N-0100	Digital Cable 185°C Nylon
	AD185SS-0100	Digital Cable 185°C SS & Nylon

ALARMLINE II DIGITAL CONTROL UNIT (OPTIONAL)

ADLCU	Alarmline II Digital LHD Location Control unit
-------	--

Alarmline II analogue sensor cable providing cable tray protection

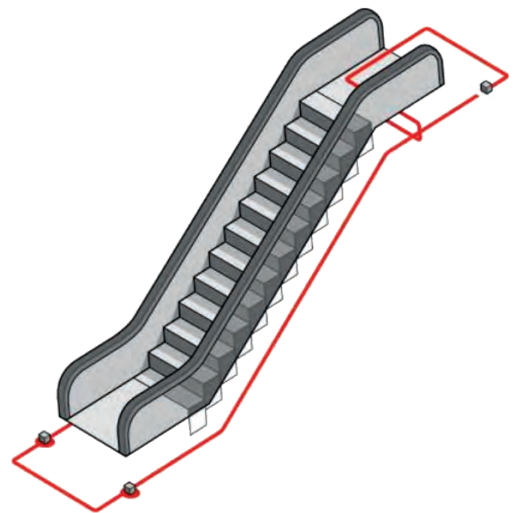
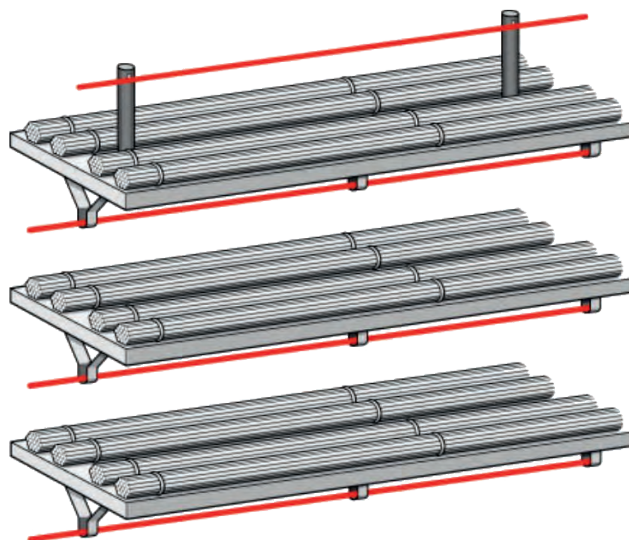

PATOL
FIRE DETECTION SOLUTIONS

Patol linear heat detection cable also available. Please call for details.

All product specifications are supplied by the manufacturer. All manufacturers reserve the right to change specification without notification.

ALARMLINE II ANALOGUE SYSTEM

Alarmline II Analogue Linear Heat detection systems are a flexible, durable and cost-effective form of fire detection, suitable for protecting a wide range of commercial and industrial applications. They provide flexibility in installation, enabling them to be used for general area protection or proximity detection close to a specific point of risk. A wide range of alarm and pre-alarm temperatures, protective coatings and installation fixings ensure system design and installation is specific to the risk. Alarmline II Analogue sensor cables are especially suited for confined areas and harsh environmental conditions, which prohibit the use of other forms of detection. Alarmline II Analogue control unit provides monitoring of the sensor cable and allows full integration with any fire alarm control system.

ALARMLINE II ANALOGUE SYSTEM**ALARMLINE II ANALOGUE CONTROL UNITS**

A	AACUSP	Analogue LHD Control Unit - Self Programmable
	AACULP	Analogue LHD Control Unit - PC Programmable
	AACU-PCC	Alarmline II Analogue LHD PC Software c/w USB Cable

STANDARD PVC COATED SENSOR CABLE (RED)

B	AA-0100	(100m) Analogue LHD Cable PVC Coated
C	AA-0500	(500m) Analogue LHD Cable PVC Coated

NYLON COATED SENSOR CABLE

	AAN-0100	(100m) Analogue LHD Cable Nylon Coated
	AAN-0500	(500m) Analogue LHD Cable Nylon Coated

POLYPROPYLENE COATED SENSOR CABLE

	AAP-0100	(100m) Analogue LHD Cable Polythene Coated
	AAP-0500	(500m) Analogue LHD Cable Polythene Coated

PVC COATED SENSOR CABLE WITH STAINLESS STEEL OUTER BRAID

	AASS-0100	(100m) Analogue LHD Cable Stainless Steel & PVC Coated
	AASS-0500	(500m) Analogue LHD Cable Stainless Steel & PVC Coated

NYLON + STAINLESS STEEL BRAIDED

	AASSN-0100	(100m) Analogue LHD Cable Stainless Steel & Nylon Coated
	AASSN-0500	(500m) Analogue LHD Cable Stainless Steel & Nylon Coated

ALARMLINE II**ALARMLINE II INSTALLATION ACCESSORIES****ALARMLINE SPECIAL APPLICATION ACCESSORIES**

D	B6782-032	Cable Collector, Stainless Steel
	B6782-170	Retractable Cable – 30m
	53836-K241EX	Automatic Cable Reeler - Stainless Steel c/w Ex Polycarbonate Junction Box
	53836-K247EX	Automatic Cable Reeler - Stainless Steel c/w Stainless Steel Junction Box
	B6782-189	Ex Junction Box c/w 2 Cable Glands
	B6782-190	Ex Junction Box c/w 3 Cable Glands
	ACA-JBW	Junction Box, IP65/66 w/ Cable Glands & Terminals

ALARMLINE ANALOGUE AND DIGITAL SENSOR CABLE FIXINGS

E	ACA-CE02-025	"Edge" Clip, (Spring Steel) 2-3mm (3-8mm, 8-14mm, 14-20mm available) - Pack of 25
	ACA-B706-025	"7" Bracket (Pipe Clip), 60mm (2.4") (Zintec) c/w Silicon Sleeve - Pack of 25
	ACA-B706SS-025	Pipe Clip - Stainless Steel c/w Silicon Sleeve - Pack of 25
	B6782-023	"V" Bracket, (Spring Steel)
	ACA-BVSS-025	"V" Bracket, (Stainless Steel) c/w Silicon Sleeve - Pack of 25
	B6782-154	"L" Bracket c/w Strain Relief Bush
	ACA-BU06-025	"U" Bracket, 60mm (2.4") (Zintec) c/w Silicon Sleeve - Pack of 25
	ACA-BL05-025	"L" Bracket, 50mm (2") (Zintec) c/w Silicon Sleeve - Pack of 25
	ACA-BL05SS-025	"L" Bracket, 50mm (2") Stainless Steel c/w Silicon Sleeve - Pack of 25
	ACA-BL10-025	"L" Bracket, 100mm (200mm available) (Zintec) c/w Silicon Sleeve - Pack of 25
	ACA-BL10SS-025	"L" Bracket, 100mm (200mm available) Stainless Steel c/w Silicon Sleeve - Pack of 25
	ACA-RS-025	Silicon Sleeve - Pack of 25
	ACA-TW11W-025	Tie Wrap (PA66) 110°C (230°F) - Pack of 25
	ACA-TW17W-025	Tie Wrap (PA66) 170°C (338°F) - Pack of 25
	ACA-TWSS-025	Tie Wrap Stainless Steel - Pack of 25
	ACA-TWT	Stainless Steel Tie Wrap Tool



Aspirating Smoke Detection (also known as “Air Sampling”) is a method of smoke detection where a sample of air from the protected area is drawn into a pipe & passed through a Laser Detection Chamber for analysis. These systems are not intended to compete with standard point detection devices where cost, ease of installation & compliance are the main criteria, but are designed for areas of high risk from fire where early warning is imperative, or where consequential loss would be high value.

VESDA[®]
by **xtralis**

A

VESDA VLI

The VESDA VLI is an industrial-strength detection category that will benefit customers in critical but often harsh environments. With its patented, innovative technology, the VESDA VLI sets a new benchmark for reliable, absolute smoke detection in industrial applications including mining, manufacturing, processing plants, petrochemical plants, power generation facilities, waste treatment plants and more.



A

B

VESDA VEP

The VESDA-E VEP Series of Aspirating smoke detectors extend the reach of the VESDA-E platform to a wide range of applications. VEP sensitivity range is from 0.005 to 20% obs/m (0.0016 to 6.25% obs/ft) and provides upto 40 class A holes. VEP is equipped with a powerful aspirator that provides a total of 130m (427ft) in the one pipe model and 560m (1837ft) in the four pipe model. VEP also provides staX support, ethernet, wifi, usb and VESDAnet capabilities. .



B

C

VESDA VLF (LASERFOCUS)

The VESDA VLF delivers the most advanced and cost-effective aspirating smoke detection technology for small environments. The VESDA VLF-250 model protects areas up to 250m² (2,500 sq. ft) and the VESDA VLF-500 model covers up to 500m² (5,000 sq. ft). In addition to the features found in all Xtralis Laser products, VESDA VLF provides a new range of features and built-in intelligence for quick installation, commissioning and servicing.



C

REMOTE DISPLAYS & PROGRAMMERS

The VESDA display module monitors and reports the status of a detector, providing visual representation of smoke levels along with all alarm and fault conditions. For monitoring convenience, multiple displays can be associated with a single detector. The menu-driven VESDA Programmer allows the user to conveniently configure, commission and maintain the VESDA system, as well as program each individual detector. Only one programmer is needed to support the entire network. Display and programmer modules can be mounted in a detector unit separately (connected via VESDAnet), in a single remote mounting box, or in a 19-inch sub rack.

All product specifications are supplied by the manufacturer. All manufacturers reserve the right to change specification without notification.

VESDA ASPIRATING SMOKE DETECTION

VESDA VLF DETECTORS

- A** VLF-250 Vesda VLF Detector Unit (for areas up to 2,500 sq. feet)
- VLF-500 Vesda VLF Detector Unit (for areas up to 5,000 sq. feet)

VESDA VEP DETECTORS

- VEP-A10-P Vesda VEP Detector with Standard Display
- VEP-A00-P Vesda VEP Detector with LCD Programmer & Display
- B** VEP-A00-1P Vesda VEP Detector with 1 Pipe & LCD Programmer & Display

VESDA VLI DETECTORS

- C** VLI-880 Vesda VLI Detector with Relays & Ethernet Only
- VLI-885 Vesda VLI Detector with VESDAnet

VESDA VES DETECTORS

- VES-A10-P Vesda VES Detector with Standard Display
- VES-A00-P Vesda VES Detector with LCD Programmer & Display

VESDA POWER SUPPLY UNITS

- VPS-215-E5 0.5 Amp 24V DC Boxed PSU EN54 (Requires 2 x 7Ah Batteries)
- VPS-220-E5 0.5 Amp 24V DC Boxed PSU EN54 (Requires 2 x 12Ah Batteries)
- VPS-250-E5 2 Amp 24V DC Boxed PSU EN54 (Requires 2 x 38Ah Batteries)

VESDA PIPEWORK

- RED3MP Vesda 25mm Red Pipe 3M Length (Pack of 20)
- REDSOC Vesda 25mm Socket Union to Connect Pipes (Pack of 10)
- REDUN Vesda 25mm Socket Union to Connect to Vesda Unit (Pack of 10)
- REDMAB0250 Vesda 25mm to 3/4" Socket Adaptor (Pack of 10)
- RED90 Vesda 25mm 90 Degree Bend (Pack of 10)
- RED45 Vesda 25mm 45 Degree Elbow (Pack of 10)
- REDENDC Vesda 25mm End Cap (Pack of 10)
- REDTP Vesda 25mm 'T' Piece (Pack of 10)
- REDCLIP Vesda 25mm Red Pipe Clip (Pack of 20)
- REDCEM Vesda 250ml Solvent Cement

VESDA SAMPLING POINT

- 059-001 Vesda Flush Sampling Point Kit
- 128-014 Vesda Sampling Point Label (Roll of 100)

VESDA SPARES

- VSP-005 Vesda Filter Cartridge
- VSP-025 Vesda Filter Cartridge (Pack of 20)
- VSP-850-G Vesda In Line Air Filter 25mm Inlet
- VSP-855-4 Vesda In Line Filter Elements (Pack of 4)



ASPIRATING TEST KITS

SCORPION KITS

- SCORP1001-001 Scorpion Point Head Installation Kit
- SCORP2001-001 Scorpion ASD Head Installation Kit
- SCORP8000-001 Scorpion Control Panel
- SCORP7000-001 Scorpion Engineers Portable Controller
- SCORP50-001 Scorpion Battery Pack
- SCORP60-001 Scorpion Battery Baton Cable

For use with aspirating systems. Fixed solution for inaccessible areas, e.g. lift shafts, stairwells, data centres and escalators.



HONEYWELL FAAST



FAAST

- D** FL0111E-HS-EB FAAST LT-200 - 1 Channel - (160m 18 holes) c/w Earth bar
- FL0112E-HS-EB FAAST LT-200 - 1 Channel - Double Knock - (160m 18 holes) c/w Earth Bar
- FL0122E-HS-EB FAAST LT-200 - 2 Channel - (160m 18 holes per channel) c/w Earth Bar

FAAST FLEX

- FLX-010 ASD Single Channel
- FLX-020 ASD Dual Channel

All product specifications are supplied by the manufacturer. All manufacturers reserve the right to change specification without notification.

STRATOS ASPIRATING SMOKE DETECTION



MICRA SINGLE PIPE

- A** 30725 Stratos Micra 10 (Maximum Pipe Length 50 Metres)
- B** 30671 Stratos Micra 25 Single Pipe Detector (Maximum Pipe Length 50 Metres)
- 30760 Stratos Micra 25 with Relay Input Card (Maximum Pipe Length 50 Metres)

MICRA 2 PIPE

- C** 30672 Stratos Micra 100 2 Pipe (Maximum Pipe Length 50 Metres)
- 30764 Stratos Micra 100 2 Pipe with Relay Input Card (Maximum Pipe Length 50 Metres)

HSSD2 4 PIPE

- 30621 Stratos HSSD Standard Detector 4 Pipe (Maximum Pipe Length 50 Metres)

MODULASER

- 9-30780 Modulaser Minimum Display Module
- D** 9-30781 Modulaser Standard Display Module
- 9-30782 Modulaser Command Module
- D** 9-30783 Modulaser Detector Module

POWER SUPPLY

- STX2402-E 2 Amp EN54 PSU 24V DC (Requires 2 x 17Ah Batteries)

PIPEWORK

- CM10900 Red Pipe 3 Metre Length (3/4" Nominal Bore)
- CM10905 45 Degree Elbow Red 3/4"
- CM10906 90 Degree Bend Red 3/4"
- CM10908 Joining Socket Red 3/4"
- CM10909 T Piece Red 3/4"
- CM10915 Socket Union Red 3/4"
- CM10927 End Cap Red 3/4"
- CM10946 3/4" Female to 25mm Male Adapter Red
- CM10954-25 Pipe Clip Red 3/4" Pack of 25
- CM10954-100 Pipe Clip Red 3/4" Pack of 100
- CM10933 Hole Repair Saddles 3/4"
- CM10950 Clear Solvent Cement (250ml with Brush)

SAMPLING POINTS

- 21888-K074 Capillary Flush Sampling Point & Flexible Tube
- CM10960 Sampling Hole Warning Labels (100 Per Roll)

INTERFACE CARDS

- E** 30430 Stratos APIC Card (Apollo Protocol)
- 30433 Stratos APIC Card (Notifier Protocol)
- 30438 Stratos APIC Card (Hochiki Protocol)

SPARES

- 30755 Stratos Micra/Nano Dust Filter
- 30699 Stratos HSSD2 Dust Filter
- 21888-K030 Smoke Pellets 13g 40 Second Burn Time (Pack of 6)

TITANUS ASPIRATING SMOKE DETECTORS



TITANUS MICROSENS

- F** AD-05-4300 Detection Unit Micro Sens - Basic Device
- AD-05-4320 Detection Unit Micro Sens - Bar Graph
- AD-10-1400 Front Film Sheet Micro Sens

TITANUS PROSENS

- AD-05-0458 Basic Device Pro Sens SILENT 1 Alarm per Detector
- AD-10-5130 Detector Module f. Pro Sens & SILENT
- AD-05-0467 Basic Device Pro Sens FREEZE 1 Alarm per Detector
- AD-10-5200 Detector Module f. Pro Sens FREEZE
- AD-10-1035 Front Film TP-1 for 1 detector. Wagner Logo

TITANUS TOPSENS

- AD-05-1220 Basic Device Top Sens 3 Alarm & Bargraph per Detector
- AD-10-5250 Detector Module TT f. Pro Sens/Net & SILENT
- AD-10-1205 Front Film TT-1 for 1 Detector Wagner Logo
- 0920-6445 Network Card TITANUS Top Sens + Data Logger

All product specifications are supplied by the manufacturer. All manufacturers reserve the right to change specification without notification.

ALARMSENSE PANELS

C-TEC CFP (Requires up to 2 X 3.2Ah Batteries)

CFP702-2AS AlarmSense 2 Zone Control Panel

CFP704-2AS AlarmSense 4 Zone Control Panel

A CFP708-2AS AlarmSense 8 Zone Control Panel

KENTEC SIGMA (Requires up to 2 X 7Ah Batteries)

KA11020M2 Sigma CPA AlarmSense 2 Zone Surface Fire Panel

KA11040M2 Sigma CPA AlarmSense 4 Zone Surface Fire Panel

B KA11080M2 Sigma CPA AlarmSense 8 Zone Surface Fire Panel

HAES ECLIPSE (Requires up to 2 X 3.2Ah Batteries)

ALS-2 Eclipse 2 Zone AlarmSense 2 Wire Fire Panel

C ALS-4 Eclipse 4 Zone AlarmSense 2 Wire Fire Panel

HAES EXCEL (Requires up to 2 X 7Ah Batteries)

ASP4 4 Zone AlarmSense PLUS 2 Wire Fire Panel

ASP8 8 Zone AlarmSense PLUS 2 Wire Fire Panel

ASP12 12 Zone AlarmSense PLUS 2 Wire Fire Panel



AlarmSense

**A****B****C**

ALARMSENSE DEVICES

SMOKE DETECTORS

55000-390APO AlarmSense Optical Smoke Detector

55000-391APO AlarmSense Integrating Optical Smoke Detector

HEAT DETECTORS

55000-190APO AlarmSense Heat Detector A1R

55000-193APO AlarmSense High Temperature Heat Detector CS

BASES

45681-244APO AlarmSense Detector Base

45681-509APO AlarmSense Sounder Beacon Base

45681-510APO AlarmSense Sounder Base

45681-294 AlarmSense Locking Cap in White (for 45681-509/510)

OPEN AREA SOUNDER BEACONS

55000-017APO AlarmSense Red Open Area Sounder Beacon

55000-018APO AlarmSense Red Open Area Sounder

CALL POINT

55400-894APO AlarmSense Surface Manual Call Point

44251-175APO Perspex Hinged Call Point Cover for SA5900-908 Series Call Point (Per 10)

RELAY

55000-835APO AlarmSense Relay Module



AlarmSense



All product specifications are supplied by the manufacturer. All manufacturers reserve the right to change specification without notification.

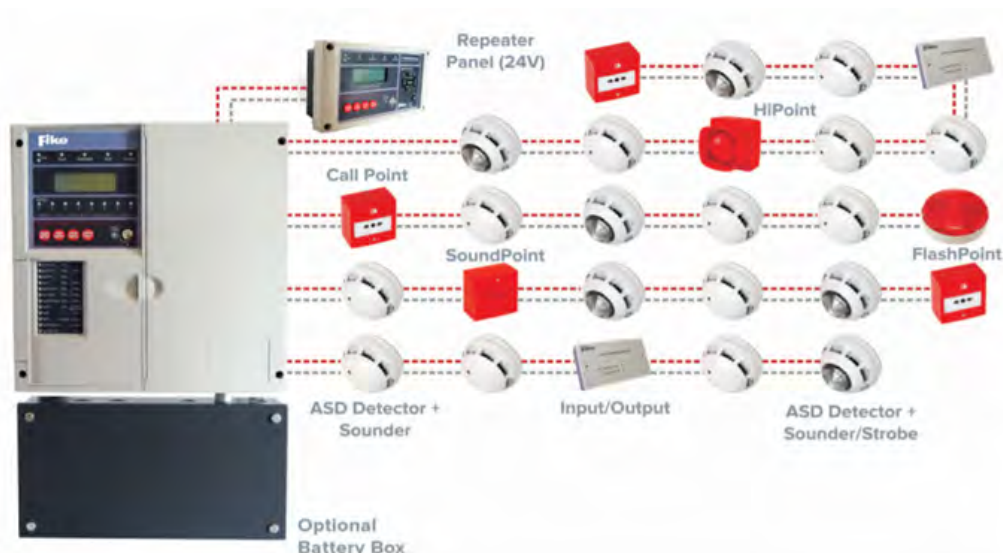

FIKE TWINFLEX

TWINFLEX^{pro}2



TWINFLEX PRO² PANEL (Requires up to 2 X 3.2Ah Batteries)

505-0002 Twinflex Pro² 2 Zone Fire Alarm Panel

505-0004 Twinflex Pro² 4 Zone Fire Alarm Panel

A 505-0008 Twinflex Pro² 8 Zone Fire Alarm Panel

TWINFLEX PRO² EXPANSION CARD

505-0006 Twinflex Pro² 4 Zone Expansion Card (Can only be used with 505-0004 4 Zone Panel)

TWINFLEX PRO² REPEATER PANEL

505-0010 Twinflex Pro² Repeater Panel (For use with 4 & 8 Zone Panels only)

TWINFLEX ASD DETECTORS

B 204-0003 Twinflex ASD Multipoint (no Sounder)

204-0001 Twinflex ASD Multipoint with Sounder

204-0012 Twinflex ASD Multipoint with Sounder & Strobe

CALL POINTS - NOW INCLUDING COVERS

C 402-0006 Twinflex Surface or Flush Call Point

402-0007 Twinflex Weatherproof Call Point

45-0022-5 Spare Key for Twinflex Call Point (Pack of 5)

SOUNDERS

D 302-0001 Twinflex Hatari Red Sounder 97dB (also available in white)

313-0021 Twinflex Square Red Sounder 85dB (also available in white)

IP65 SOUNDER

302-0004 Twinflex 90dB Industrial Weatherproof Sounder IP55

SOUNDER STROBE

E 302-0012 Twinflex Sounder / Flashpoint 90dB

STROBE

302-0023 Twinflex Flashpoint IP52

I/O UNIT

F 802-0006 Twinflex Input/Output Module

TWINFLEX PRO² BOXED KIT

604-0002 Twinflex Pro² Boxed Kit comprising of :- 1 x Twinflex Pro² 2 Zone Panel, 7 x Twinflex Multipoint ASD with sounder, 2 x Twinflex Manual Call Point, 1 x Head Removal Tool

604-0004 Twinflex Pro² Boxed Kit comprising of :- 1 x Twinflex Pro² 4 Zone Panel, 7 x Twinflex Multipoint ASD with sounder, 2 x Twinflex Manual Call Point, 1 x Head Removal Tool

604-0008 Twinflex Pro² Boxed Kit comprising of :- 1 x Twinflex Pro² 8 Zone Panel, 7 x Twinflex Multipoint ASD with sounder, 2 x Twinflex Manual Call Point, 1 x Head Removal Tool

All product specifications are supplied by the manufacturer. All manufacturers reserve the right to change specification without notification.

SAV-WIRE - TRIED & TESTED 2 WIRE CONVENTIONAL FIRE ALARM SYSTEM

The Sav-Wire system is the original 2 wire concept, using standard Apollo Series 65 or Hochiki CDX detector with dedicated Sav-Wire bases & call points.
Any conventional low current 24V DC sounder can be wired onto the same pair as the smoke detectors.

KENTEC**SAV-WIRE PANELS** (Requires up to 2 X 7Ah Batteries)

	T11020M2	Kentec 2 Zone Sav-Wire Surface Panel
A	T11040M2	Kentec 4 Zone Sav-Wire Surface Panel
	T11080M2	Kentec 8 Zone Sav-Wire Surface Panel
	E01020L2	Kentec 2 Zone Surface Repeater Panel
	E01040L2	Kentec 4 Zone Surface Repeater Panel
	E01080L2	Kentec 8 Zone Surface Repeater Panel

**HAES****ECLIPSE SAV-WIRE PANELS** (Requires up to 2 X 3.2Ah Batteries)

B	ECL-2	Eclipse 2 Zone Fire Alarm Panel 4 Wire or Sav-Wire
	ECL-4	Eclipse 4 Zone Fire Alarm Panel 4 Wire or Sav-Wire
	FMK-ECL	Recessing Bezel for Eclipse 2 & 4 Zone Panel

**EXCEL SAV-WIRE PANELS** (Requires up to 2 X 7Ah Batteries)

	XLEN- 4	Excel 4 Zone Fire Alarm Panel 4 Wire or Sav-Wire
	XLEN- 6	Excel 6 Zone Fire Alarm Panel 4 Wire or Sav-Wire
	XLEN- 8	Excel 8 Zone Fire Alarm Panel 4 Wire or Sav-Wire
	XLEN-12	Excel 12 Zone Fire Alarm Panel 4 Wire or Sav-Wire
	FMK-XLEN	Recessing Bezel for Excel 4-12 Zone Panel

SAV-WIRE COMPATIBLE DEVICES**DETECTORS & BASES**

C	55000-317APO	Series 65 Optical Smoke Detector
	55000-122APO	Series 65 Rate Of Rise Heat Detector A1R 57c
	55000-127APO	Series 65 Rate Of Rise Heat Detector BR 75c
	55000-132APO	Series 65 Rate Of Rise Heat Detector CR 90c
	55000-137APO	Series 65 Fixed Temperature Heat Detector CS 90c
	45681-206APO	Series 65 Sav-Wire Detector Base

CALL POINTS

	M1B-R470SGSTK01	Red Sav-Wire Call Point
	WCP1B-R470SF01	Red Sav-Wire Resettable Call Point IP67
	PS200	Hinged Call Point Cover

SOUNDERS & BEACONS

	SQ-SV-S-W	Squashni Sounder Base 28 Tone 10-28V DC 18mA 93dB
	ROLP-SV-R-3	Roshni Red Sounder 9-28V DC 12mA 102dB (No Base)
	ROLPSB-SV-RL-R-N	Roshni Red Sounder/LED Beacon 18-28V DC 21mA 102 dB (No Base)
D	SO-R-NB-3C	Solex Red Beacon 10-60V DC 25mA (No Base)
E	SQ-G3-23	Squashni VAD Sounder Base with White Flash EN54-23

BASES FOR SOUNDERS & BEACONS

	SR01	Red Shallow Base
	DR01	Red Deep Base IP65
	UR01	Red 'U' Base IP65

VISUAL ALARM DEVICES TO EN54-23

	ROLPBSELX-W-RFR1	Red VAD Base 18-28V 28mA EN54-23 (Requires Roshni Sounder)
	SOL-LX-W-RF-R1-S	Solista Red Wall VAD, with Shallow Base 9-60V DC 10-25mA EN54-23
F	SOL-LX-C-RF-W1-S	Solista White Ceiling VAD, with Red Flash & Shallow Base 9-60V 10-25mA EN54-23



EMS FIRECELL WIRELESS ALARM SYSTEM



CONTROL EQUIPMENT

- A** FC-LA80161-M2 FireCell 1 Loop Master Surface Control Panel with Key Enable
- FC-A80162-M2 FireCell 2 Loop Master Surface Control Panel with Key Enable
- B** FCX-532-001 FireCell Fusion Radio Loop Module (Up to 5 Per Loop)

FIRE DETECTORS

- C** FCX-177-001 FireCell Optical Smoke Detector
- FCX-175-001 FireCell A1R Heat Detector
- FCX-176-001 FireCell CS Heat Detector
- FCX-170-001 FireCell Wireless Detector Base (Includes Batteries)
- FCX-191-000 FireCell Wireless Detector Sounder Base (Includes Batteries)
- D** FCX-191-200 FireCell Wireless Detector Sounder/ Red Visual Indicator Base (Includes Batteries)

SOUNDERS & BEACONS

- FC-315-WA2 FireCell Wireless Wall Sounder & Beacon
- FC-171-002 FireCell Wireless Base for Audio Visual Devices (Includes Batteries)

MODULES

- FC-620-001 FireCell Auxiliary Relay Module
- FC-610-001 FireCell Wireless Input/Output Module (Includes Batteries)
- FC-868-SE2 FireCell Wireless Survey Kit

CALL POINTS

- E** FC-200-002 FireCell Wireless Red Surface Manual Call Point (Includes Batteries)
- PS200 Hinged Call Point Cover

EDA ZERIO PLUS



CONTROL EQUIPMENT

- F** EDA-Z5008 8 Zone Control Panel
- EDA-Z5020 20 Zone Control Panel
- EDA-Z5100 100 Zone Control Panel
- EDA-Z6000 Radio Booster Unit (Requires 240V Supply)
- EDA-Z6010 Wired Intelligent Antenna
- EDA-Z5008FS 8 Zone Flush Mounted Wired Remote Display
- EDA-Z5008SS 8 Zone Surface Mounted Wired Remote Display
- EDA-Z5008SZ 8 Zone Standard Enclosure Wired Remote Display
- EDA-Z5000 Survey Kit

DEVICES

- G** EDA-R5000 Radio Optical Smoke Detector
- EDA-R6000 Radio Optical Smoke Detector with Combined Sounder
- H** EDA-R6030 Radio Optical Smoke Sounder Detector with Beacon
- EDA-D5000 Radio Heat Detector
- EDA-D6000 Radio Heat Detector with Combined Sounder
- I** EDA-C5000 Radio Call Point / Break Glass Unit
- PS200 Hinged Call Point Cover
- EDA-T5000 Radio Transmitter Unit
- EDA-T5100 Radio Silence Alarm Button

SOUNDERS & OUTPUT UNITS

- EDA-A6000 Radio Sounder
- J** EDA-A6030 Radio Sounder with Beacon Combined
- EDA-A6060 Radio LED Beacon
- EDA-T6080 Radio Clean Contact Input/Output Unit

All product specifications are supplied by the manufacturer. All manufacturers reserve the right to change specification without notification.

EMS SMARTCELL

CONTROL PANEL

- A** SC-11-1201-0001 SmartCell 230V Control Panel
- SC-11-2201-0001 SmartCell 24V Control Panel

FIRE DETECTORS

- B** SC-21-0200-0001 SmartCell Smoke/Heat Detector
- SC-22-0200-0001 SmartCell Smoke/Heat and Sounder
- SC-23-0220-0001 SmartCell Smoke/Heat and Sounder VAD

SOUNDERS & BEACONS

- C** SC-31-0100-0001 SmartCell Red Sounder
- SC-31-0200-0001 SmartCell White Sounder
- SC-32-0120-0001 SmartCell Wall Sounder VAD Red
- SC-32-0220-0001 SmartCell Wall Sounder VAD White
- SC-33-0120-0001 SmartCell Ceiling Sounder VAD Red
- SC-33-0120-0001 SmartCell Ceiling Sounder VAD White

MODULES

- SC-61-0001-0001 SmartCell Comms Module
- D** SC-41-0200-0001 SmartCell Dual Input/Output Unit
- SC-71-1201-0001 SmartCell Survey Kit

CALL POINTS

- SC-51-0100-0001 SmartCell Red Manual Call Point c/w Hinged Cover



APOLLO REACH AVAILABLE ON PAGE 36

HYFIRE

CONTROL PANELS

- HF-CP1-01 Hyfire Economy 1-2 Loop Fire Alarm Control Panel
- HF-CP1-S-01 Hyfire Standard 1-2 Loop Fire Alarm Control Panel

FIRE DETECTORS

- E** HFI-PA-05 Hyfire Wireless Optical Detector
- HF-W-TA-05 Hyfire Wireless Heat Detector
- HF-W-PA-05 Hyfire Wireless Dual Optical Smoke Detector
- HF-W-MA-05 Hyfire Wireless Multi Detector
- F** HFI-DNBS-05 Hyfire Standard Detector Base

SOUNDERS & BEACONS

- HFC-WSR-03 Hyfire Conventional Wall Sounder Red
- HFC-WSW-03 Hyfire Conventional Sounder White
- HFI-ABS-05 Hyfire Addressable Sounder Base
- HFI-ABSB-05 Hyfire Addressable Loop Powered Sounder Beacon Base
- HF-W-BS-05 Hyfire Wireless Sounder Base
- HF-W-BSB-05 Hyfire Wireless Sounder Beacon Base

MODULES

- HF-W-EM-01 Hyfire Wireless Expander Module
- HFI-SIM-01 Hyfire Addressable Sounder Interface Module
- HF-W-SIM-01 Hyfire Wireless Sounder Interface Module
- G** HF-W-W2W-01 Hyfire Wireless Translator Module

CALL POINTS

- HF-W-CP-03/C Hyfire Wireless Surface Manual Call Point + Cover

PROGRAMMING

- H** HFI-DPT-05 Hyfire Altair Handheld Programming Unit



All product specifications are supplied by the manufacturer. All manufacturers reserve the right to change specification without notification.

SELF CONTAINED BATTERY POWERED SITE ALARMS



A



B

SELF CONTAINED BATTERY POWERED SITE ALARMS

A	404-006	Resettable Battery Powered Call Point c/w Sounder (Requires 2 x GP23A) (Up to 12 404-0006 can be interlinked using a 3 core cable)
B	FMCEVASMPB	Evacuator Sitemaster Push Button
	FMCEVASMBG	Evacuator Sitemaster Break Glass

EVACUATOR



C



D

EVACUATOR SYNERGY SITE ALARMS

	FMCEVASYN2	Evacuator Synergy Call Point
	FMCEVASYNBS	Evacuator Synergy Base Station
C	FMCEVASYNBS40	Evacuator Synergy Touch Screen 40
	FMCEVASYNSS	Evacuator Synergy Sounder Strobe
	FMCEVASYNHD	Evacuator Synergy Heat Detector
	FMCEVASYNSD	Evacuator Synergy Smoke Detector
	FMCEVAINT2	Evacuator Synergy Relay Interface

ROTARY BELL/AIR HORN

	FMCRAB10	Rotary Hand Bell
D	AIRHORN1	Airhorn

EVACUATOR SYNERGY + SITE ALARMS

	FMCEVASYNP1	Evacuator Synergy + Call Point
	FMCEVASYNP2	Evacuator Synergy + Base Station
	FMCEVASYNP3	Evacuator Synergy + Heat Detector
	FMCEVASYNP4	Evacuator Synergy + Smoke Detector

Howler Site Alarms, Bull Products and WES Wireless Fire Safety and Security Technology available on request.



All product specifications are supplied by the manufacturer. All manufacturers reserve the right to change specification without notification.

EVACUATOR

SYNERGY+

Designed specifically for construction projects and temporary sites, the brand new Evacuator Synergy+ range features impressive durability and boasts a user-friendly interface. The Synergy+ range not only has a new design, but a brand new in-house designed chip, INFINITY 2, allowing users to access their system through cloud based remote monitoring and store up to 250 devices in one system. A secure mesh network can be created that is unique to your site and will not interfere with neighbouring sites that may also be using Synergy+ products.



SYNERGY+ BASE STATION

- Mains operated or Optional Battery Back up as an option.
- First Aid Call function
- Category One radio module
- CE ROHS & EMC Compliant
- Secure Reset Function
- Totally wire free operation
- Zoning function
- Engineer and site manager mode
- 85db buzzer



SYNERGY+ CALL POINT

- 3 years battery life
- Category One radio module
- CE ROHS & EMC Compliant
- 110db Sounder and Strobe
- Mesh radio connectivity
- EN54 Call Point
- Radio frequency 869Mhz
- 2Km line of sight range between devices
- Status LEDs
- IP55 Rated



SYNERGY+ CALL POINT

- 3 years battery life
- Category One radio module
- CE ROHS & EMC Compliant
- 110db Sounder and Strobe
- Mesh radio connectivity
- EN54 Call Point
- Radio frequency 869Mhz
- 2Km line of sight range between devices
- Status LEDs
- IP55 Rated



SYNERGY+ HEAT DETECTOR

- Optical 57° Detector
- Up to 3 years battery life
- Category One radio module
- CE ROHS & EMC Compliant
- Battery low indication
- Secure reset function
- EN54 Detector
- Totally wire free operation
- Mesh radio connectivity
- Radio Frequency 869Mhz
- 2Km line of sight range
- Indoor use only



SYNERGY+ GSM3

- Mains powered or Optional Battery Backup
- Text up to 5 numbers on alarm
- Category One radio module
- CE ROHS & EMC compliant
- Text up to 5 numbers on First Aid.
- Off site remote reset
- Mesh radio connectivity
- Radio Frequency 869Mhz
- Optional SIM card packages available
- Indoor use only



SYNERGY+ RELAY INTERFACE

- Up to 3 years battery life
- Category One radio module
- CE ROHS & EMC Compliant
- Battery low indication
- Status LEDs
- Totally wire free operation
- Mesh radio connectivity
- Radio Frequency 869Mhz
- Used to trigger other systems and devices
- N/O & N/C contacts.



SYNERGY+ SOUNDER STROBE

- 3 years battery life
- Category One radio module
- CE ROHS & EMC Compliant
- Battery low indication
- Secure reset function
- Status LEDs
- Totally wire free operation
- 110dB Sounder and Strobe
- Mesh radio connectivity
- Radio Frequency 869Mhz
- Rated IP55



SYNERGY+ SMOKE DETECTOR

- Optical Smoke Detector
- Up to 3 years battery life
- Category One radio module
- CE ROHS & EMC Compliant
- Status LEDs
- EN54 Detector
- Totally wire free operation
- Mesh radio connectivity
- Radio Frequency 869Mhz
- 2Km line of sight range
- Indoor use only

We are able to supply Analogue Addressable Panels from single loop to 8 loop, and/or multipanel networks supporting a range of manufacturers protocols, including Apollo, Hochiki, Nittan, Argus Vega, System Sensor and Cast.

ADVANCED ELECTRONICS MXPRO5 (APOLLO & HOCHIKI PROTOCOL)



MX5101 PANELS

- 500mA Loop Current
- 2 x Programmable Sounder Circuits
- 3 Amp PSU
- Space for 7Ah Batteries
- Size H340 x W340 x D85



MX5202 PANELS

- 500mA Loop Current
- 2 x Programmable Sounder Circuits
- 5 Amp PSU
- Space for 12Ah Batteries
- Size H340 x W430 x D115



MX5404 PANELS

- 500mA Loop Current
- 4 x Programmable Sounder Circuits
- 5 Amp PSU
- Space for 18Ah Batteries
- Size H470 x W450 x D115

MX-5101	1 Loop 20 Zone Fire Panel.
MX-5202	1-2 Loop 20 Zone Fire Panel. c/w 2 Loop Cards
MX-5404	1-4 Loop 20 Zone Fire Panel. c/w 4 Loop Cards
MX-5808	2-8 Loop 20 Zone Fire Panel. c/w 8 Loop Cards. Standard Network
MXP-502	Loop Driver Card
MXP-513L-050RD	MX-5000 50 Zone LED Card (Red) (MX-5400 only)
MXP-513L-100RD	MX-5000 100 Zone LED Card (Red) (MX-5400 only)
MXP-503	MX-5000 Standard Network Card
MXP-509	MX-5000 Fault Tolerant Network Card
MXP-511	Access Enable Keyswitch Assembly
MXP-516	Keyswitch Assembly - Trapped Key
MXP-517	Keyswitch Assembly - Untrapped Key
MXP-507	MX-5000 Two Way Relay Card
MXP-512	MX-5000 Printer Assembly
MX-5010	Passive Repeater Panel (RDT)
MX-5010FT	Passive Repeater Panel (RDT), Fault Tolerant
MX-5020	Fully Functional Repeater (RCT)
MX-5020FT	Fully Functional Repeater (RCT), Fault Tolerant
MXM-501	Semi-Flushing Bezel for MX5101
MXM-502	Semi-Flushing Bezel for MX5201 & 5202
MXM-503	Semi-Flushing Bezel for MX5401-5404
PC-NET-003-USB	Configuration Software & USB Upload/Download Lead
TOUCH-10	Touch Screen Terminal - Standard Network
TOUCH-10FT	Touch Screen Terminal - Fault Tolerant Network

Also available in Nittan and Argus Vega Protocol.

ADVANCED GO PANELS (APOLLO & HOCHIKI PROTOCOL)



GO1 PANELS

- 2 X Programmable sounders
- 2 x Address Size Options
- 1 Loop
- Non Networkable
- Space for 7Ah Batteries
- Size H345 X W345 X D87

GO1	1 Loop Fire Alarm Panel, 50 Addresses
GO1+	1 Loop Fire Alarm Panel, 126/127 Addresses



Book your place on
our FIA certified
CPD A Guide to
Meeting BS 8629



EvacGo

The evacuation alert system for easy BS 8629 compliance

**Building Regulations
now require
evacuation alert
system installation
in all residential new
builds over 18m.***

EvacGo makes it easy to comply with the Approved Document B amendments. Wired, wireless and hybrid options, plus a choice of leading sounder protocols, give you full design flexibility to meet the needs of your site.

This robust system combines proven power and performance with simple operation for fast, effective resident notification in fire situations – ensuring safe evacuation and complete peace of mind.

Creating a safer future

Please call our sales team on 01425 658241 details

*In England and Scotland.

Advanced – made in the UK. Trusted around the world.

Discover more: advancedco.com | enquiries@advancedco.com | +44 (0)345 894 7000



C-TEC XFP 1 & 2 LOOP PANELS (CAST, APOLLO & HOCHIKI PROTOCOL)



XFP501E SINGLE LOOP

- 2 x Sounder Circuits
- 1.4 Amp PSU
- Space for 2 x 3.2Ah batteries
- Size H235 x W235 x D77



XFP501 & 502

- 2 x Sounder Circuits
- 3 Amp PSU
- Space for 2 x 7Ah batteries
- Size H274 x W439 x D87

XFP 1 & 2 LOOP CAST PROTOCOL

XFP501E/CA	16 Zone Single Loop Fire Panel. CAST
XFP501/CA	32 Zone Single Loop Fire Panel. CAST
XFP502/CA	32 Zone Two Loop Fire Panel. CAST

XFP 1 & 2 LOOP APOLLO PROTOCOL

XFP501E/X	16 Zone Single Loop Fire Panel. XP95 & Discovery
XFP501/X	32 Zone Single Loop Fire Panel. XP95 & Discovery
XFP502/X	32 Zone Two Loop Fire Panel. XP95 & Discovery

XFP 1 & 2 LOOP HOCHIKI PROTOCOL

XFP501E/H	16 Zone Single Loop Fire Panel. Hochiki ESP
XFP501/H	32 Zone Single Loop Fire Panel. Hochiki ESP
XFP502/H	32 Zone Two Loop Fire Panel. Hochiki ESP

REPEATER PANELS

XFP510-16	Repeater Panel 16 Zones (Panel Requires CFP761 Card)
XFP510-32	Repeater Panel 32 Zones (Panel Requires AFP711 Card)

NETWORK CARDS

CFP761	Network Comms Card for 16 Zone XFP Panel
AFP711	Network Driver Card for 32 Zone XFP Panel

C-TEC ZFP PANELS (APOLLO PROTOCOL)

ZFP 2 LOOP 20 ZONE STANDARD FIRE PANEL

- Dimensions W450 x H462 x D127
- Touchscreen controlled
- Intertek Certified EN54
- Apollo XP95/Discovery Protocol



ZFP STANDARD PANELS

ZFP1/X	1 Loop Fire Panel, XP95 & Discovery
ZFP2/X	2 Loop Fire Panel, XP95 & Discovery
ZFP2/20/X	2 Loop 20 Zone Fire Panel, XP95 & Discovery
ZFP4/20/X	4 Loop 20 Zone Fire Panel, XP95 & Discovery
ZREP1F	Flush Compact Controller c/w Network card
ZREP1S	Surface Compact Controller c/w Network card

C-TEC SOUNDERS & VADS



A



Image shown with Apollo XP95 Optical, supplied separately.

C-TEC BF456A/CX/W BASE VAD C/W 96DB(A) SOUNDER VAD

- Dimensions 122mm diameter x D46mm
- Can be mounted under an Apollo detector and base
- LPCB Certified EN54
- 14mA Alarm Current

CEILING SOUNDERS & VADS

BF451A/CX/SW Compact C-3-8 Ceiling VAD c/w 91dB sounder, white

WALL SOUNDERS & VADS

BF450A/CX/SR Compact Wall Sounder, Red

A BF451A/CX/SR Compact Wall VAD c/w 91dB Sounder, Red

HIGH OUTPUT WALL SOUNDER & VADS

BF430A/CX/SR Hi-Output 103dB Wall Sounder, Shallow, Red

BF433A/CX/DR Hi-Output W-2.4-8.2 Wall VAD c/w 103dB Sounder, Deep, red

BF453A/CX/SR Compact W-3-3.1 Wall VAD c/w Voice Sounder, Shallow, Red

BASE SOUNDERS & VADS

BF431A/CX/W White 96dB(A) Base Sounder.

BF454A/CX/W Base Voice Sounder

BF456A/CX/W White C-3-8 Base VAD c/w 96dB(A) Sounder.

BF457A/CX/W C-3-8 Base VAD c/w Voice Sounder

All product specifications are supplied by the manufacturer. All manufacturers reserve the right to change specification without notification.



World-Class Life Safety Systems

Established in 1981, C-TEC is a leading UK independent manufacturer of quality life safety electronic equipment. Trading in over 60 countries and with product certifications and factory process approvals from five different test bodies, whatever your life safety system requirements:
You're Safe with C-TEC

CFP
ACTIV
Conventional Fire Systems

HUSH
ACTIV
Residential Fire Systems

EVAC ALERT
Evacuation Alert Systems

XFP
Gart
Addressable Fire Systems



www.c-tec.com

You're safe with C-TEC



KENTEC ELECTRONICS (AVAILABLE IN APOLLO OR HOCHIKI PROTOCOL)



A



B



C

SYNCRO AS LITE 1 LOOP ECONOMY (Requires up to 2 x 9ah Batteries)

- LA81161M2 Syncro AS Lite 1 Loop 16 Zone Panel. Apollo
A LA80161M2 Syncro AS Lite 1 Loop 16 Zone Panel with Key Enable. Apollo

SYNCRO AS 1-2 LOOP STANDARD (Requires up to 2 x 9ah Batteries)

- A80161M2 Syncro AS 1 Loop 16 Zone Surface Panel with Key Enable. Apollo
 A80162M2 Syncro AS 2 Loop 16 Zone Surface Panel with Key Enable. Apollo
 K768P2 Syncro AS S Printer Module in lockable enclosure c/w Internal Key Hanger.

NETWORK CARD

- K555 Syncro AS Fault Tolerant Network Card

SERIAL REPEATER PANELS

- K67001M1 Syncro View LCD 24V Surface Repeater Panel with Key Enable
B K67751M1 Syncro View LCD 240V Surface Repeater Panel with Key Enable

SOFTWARE & DOWNLOAD LEADS

- X187LS Kentec Economy Serial Download Lead (Requires USB Converter)
 U187 Kentec USB Converter

FLUSHING COLLARS

- M2FCLGT Syncro AS & Syncro Ident Flushing Collar

LED SERIAL REPEATER PANEL

- C** K6524L2 24 Way Syncro Ident Local LED Repeater Panel, 24V, Surface

MORLEY-IAS MAX



D



E

MORLEY-IAS MAX PANELS

- MA-1000-01 Morley-IAS Max Single Loop (Non-Networkable) for System Sensor & Apollo Protocol
D MA-2000-01 Morley-IAS Max Two Loop (Networkable) for System Sensor & Apollo Protocol
E MA-8000-01 Morley-IAS Max Four Loop, Expandable to Eight (Networkable) for System Sensor & Apollo Protocol

BEZEL KITS

- MA-1BZL Morley-IAS Max MA-1000 Bezel
 MA-2BZL Morley-IAS Max MA-2000 Bezel
 MA-8BZL Morley-IAS Max MA-8000 Bezel

LOOP CARD

- MA-LIB2-01 Morley-IAS Max Dual Loop Card for MA-8000. Includes Mounting Fixtures

SIB

- E-SIB Morley-IAS Max Communication Dongle for CAN Bus & Serial TPP enablement (MA-2000 & MA-8000 only)

TOUCHSCREEN REPEATER

- MA-LCD7 Max 7" Touchscreen Repeater/Zonal Mimic

All product specifications are supplied by the manufacturer. All manufacturers reserve the right to change specification without notification.

MORLEY-IAS (MODULAR PANELS AVAILABLE IN 5 PROTOCOLS)

DXC PANELS

- A** 714-001-111 DXc1 Single Loop Panel (no zone LEDs), 2 Sounder Circuits. Supports Apollo, System Sensor and Hochiki Protocols. H260 x W390 x D147mm.
- 714-001-221 DXc2 2 Loop Control Panel (no zone LEDs), 2 sounder Circuits. Supports Apollo, System Sensor and Hochiki protocols. H391.5 x W390 x D147mm.
- 714-001-241 DXc4 4 Loop Control Panel (no zone LEDs), 2 Sounder Circuits. Supports Apollo, System Sensor and Hochiki Protocols. H391.5 x W390 x D147mm.

ZONAL LED CARDS

- 795-102 40 Zone LED Card, Includes PCB, Ribbon Cable, Zone Number Labels & Fixings
- 795-124 80 Zone LED Card, Includes PCB, Ribbon Cable, Zone Number Labels & Fixings

ACTIVATE KEYSWITCH

- 795-118 DXc Key Switch Kit

NETWORK CARD

- 795-099 DXc Network Card

BEZEL KITS

- 795-112 Flush Bezel Kit for DXc1 (small enclosure)
- 795-113 Flush Bezel Kit for DXc 2/4 (large enclosure)

ZX PANELS

- B** 722-001-301 ZX1Se Single Loop Control Panel, 2 Sounder Circuits, 4 Line Display & Networking Capability. H400 x W400 x D135mm. Order Loop Cards Separately. Supplied With 20 Zonal LED's, Not Expandable
- 720-001-301 ZX2Se 1-2 Loop Control Panel, 2 Sounder Circuits, 4 Line Display & Networking Capability. H400 x W400 x D135mm. Order Loop Cards Separately. Supplied with 20 Zonal LED's, Not Expandable
- C** 721-001-301 ZX5Se 1-5 Loop Control Panel, 4 Sounder Circuits, 4 Line Display & Networking Capability. Order Loop Cards Separately. Supplied with 20 Zonal LED's, Expandable to 40 or 80 with Part Numbers 795-077-020 or 795-077-060

LOOP CARDS

- 795-066-100 Loop Driver Card for Apollo Discovery Or XP95 Protocols
- 795-058-105 Loop Driver Card for Hochiki ESP Protocol
- 795-068-100 Loop Driver Card System Sensor Protocol
- 795-072-100 Loop Driver Card for Morley-IAS Protocol

ZONAL LED CARDS

- 795-077-020 20 Zone LED Card, Includes PCB, Ribbon Cable & Fixings. Increases the total number of Zone LEDs to 40
- 795-077-060 60 Zone LED Card, Includes PCB, Ribbon Cable & Fixings. Increases the total number of Zone LEDs to 80

PRINTER

- 795-051-001 Internal Printer for ZX5SE Panel

COMMS MODULES

- 795-004-001 RS485 Communication Card for Repeater/Network
- 795-038-001 Hi-485 Communication Module (Fault Tolerant)
- 795-005 RS232 Communication Module

RELAY MODULES

- 795-014 4 Way, Programmable Output Relay Module. Requires 24V DC Supply and an RS485 Card to be fitted in the Control Panel.
- 795-015 4 Way, Programmable Sounder Module. Requires 24V DC Supply and an RS485 Card to be fitted in the Control Panel.

REPEATER PANELS

- 709-701-001 Morley-IAS Passive Repeater. Requires 24V DC and a RS485 Card when used with a ZX Control Panel.
- D** 709-601-001 Morley-IAS Active Repeater. Silence, Mute, Reset, Accept, Evacuate & Test Controls. Requires 24V DC Supply and a RS485 Card when used with A ZX Control Panel.

FLUSH BEZELS

- 797-061 Semi-flush Mounting Kit for ZX1(S)e or ZX2(S)e Control Panel. Bezel Dimensions H450 x W450mm
- 797-062 Semi-flush Mounting Kit for ZX5(S)e Control Panel. Bezel Dimensions H550 x W550mm
- 020-600-002 Bezel Kit for Active or Passive Repeaters. Semi-flush Mounting, H218 x W307mm

PERSPEX DOOR KITS

- 797-063 ZX1SE & ZX2Se Glass Door Kit, Comprises a new inner door and plaxiglass window allowing controls to be protected and recessed within the existing enclosure
- 797-064 ZX5Se Glass Door Kit, Comprises a new Inner door and plaxiglass window allowing controls to be protected and recessed within the existing enclosure

SOFTWARE & DOWNLOAD LEAD

- 020-891 Morley-IAS USB Upload / Download Lead. The Lead Provides the Interface between a PC and any Morley-IAS Fire Alarm Control Panel.



Multi Protocol Fire Alarm Panels with loop drivers for use with Apollo XP95/Discovery, Hochiki ASX or System Sensor devices Compatible with repeater panels from the ZX range

- 500mA Loop Current
- 2 x Programmable Sounder Circuits
- 3 Amp PSU
- Space for Batteries - 2 x 7Ah in 1 Loop or 2 x 17Ah in 2 & 4 Loop
- Size - 1 Loop H260xW390xD147
- Size - 2 & 4 Loop W392xH390xD147



ZXSE panels are constructed on a modular format. Select the base panel required and then add loop cards, communication modules etc. ZXSE panels are suitable for networking applications or communicating to a computer graphics package.

- 500mA loop current
- 2 x Programmable Sounder Circuits
- 2.5 Amp PSU
- Space for batteries - 2 x 12Ah in 1 & 2 loop panels, and 2 x 24Ah in the 5 loop panel
- Size - 1 & 2 loop H400xW400xD135 and 5 loop H500xW500xD195



- Repeater Panels
- 24V
 - Size H165 x W254 x D50

N.B. ZX panels require a FPM795-004-001 RS485 card to work with repeaters.

APOLLO XP95, SOTERIA & DISCOVERY



XP95 SMOKE & HEAT DETECTORS

A	55000-600APO	XP95 Optical Smoke Detector
B	55000-400APO	XP95 Heat Detector
	55000-401APO	XP95 High Temperature Heat Detector
	55000-885APO	XP95 Combined Smoke & Heat Detector

SOTERIA DIMENSION

C	FL5100-600APO	Soteria Dimension Flush Mounted Optical Detector
	FL6100-600APO	Soteria Dimension Specialist Flush Mounted Optical Detector
	FL5000-200APO	Soteria Dimension Mounting Box

DISCOVERY SMOKE & HEAT DETECTORS

D	58000-600APO	Discovery Optical Smoke Detector
	58000-400APO	Discovery Heat Detector
E	58000-700APO	Discovery Multisensor
	58000-300APO	Discovery Carbon Monoxide Fire Detector
	58000-305APO	Discovery Carbon Monoxide & Heat Multisensor

SMOKE DETECTOR DUCT HOUSING

	53546-022APO	XP95 Duct Detector Housing with Base
--	--------------	--------------------------------------

FLAME DETECTORS

	55000-280APO	XP95 Flame Detector (Dual Infra Red)
	55000-295APO	XP95 Flame Detector in Flameproof Housing
F	55000-022APO	XP95 Base Mounted UV Flame Detector (Requires 45681-210 Base)
	55000-023APO	XP95 Base Mounted UV/IR Flame Detector (Requires 45681-210 Base)
	55000-024APO	XP95 Base Mounted IR3 Flame Detector (Requires 45681-210)
	55000-020APO	XP95 Flame Detector Triple IR
	55000-021APO	XP95 Flameproof Triple IR Flame Detector

OPTICAL BEAM DETECTOR

G	SA7100-100APO	Intelligent Auto-Aligning Beam Detector
---	---------------	---

CALL POINTS

H	SA5900-908APO	Intelligent Resetable Surface/Flush Call Point with Isolator NEW Apollo Style
	55100-908APO	XP95 Resetable Surface/Flush Call Point with Isolator OLD KAC Style
	44251-189APO	Perspex Hinged Call Point Cover for SA5900-908 (Per 1)
	44251-175APO	Perspex Hinged Call Point Cover for SA5900-908 (Per 10)
	44251-176APO	Spare Key for SA5900-908 Series Call Point (Per 10)

WEATHERPROOF CALL POINTS

	58200-951APO	Discovery/XP95 Red Call Point with Isolator IP67 NEW Apollo Style
--	--------------	---

DETECTOR BASES & BASE SOUNDER COMBINATIONS

I	45681-210APO	XP95 Detector Base with Xpert Address Card
	45681-284APO	XP95 Isolating Detector Base
	45681-276APO	XP95 Ancillary Sounder Base
	45681-277APO	XP95 Sounder Base with Isolator
J	45681-330APO	XP95 Sounder Beacon Base with Isolator
	45681-333APO	XP95 Beacon Base with Isolator
	45681-705APO	XP95 Sounder/VAD Base with Isolator (White LED's)
	45681-709APO	XP95 VAD Base with Isolator (White LED's)
	45681-292	White Cap for 45681-277 Base Sounder
	45681-293	Red Cap for 45681-277 Base Sounder

XPERT ADDRESS CARDS

	45682-800APO	XP95 Xpert Address Card (Per 25)
--	--------------	----------------------------------

APOLLO XP95 & DISCOVERY

WALL SOUNDERS

A	55000-001APO	XP95 Red Wall Sounder IP65 with Isolator
	55000-278APO	XP95 Red High Output Wall Sounder
	55000-279APO	XP95 White High Output Wall Sounder
	55000-274APO	XP95 Red Weatherproof Wall Sounder IP66

FLASHING INDICATORS

	55000-877APO	XP95 Red Ceiling LED Visual Indicator (Requires 45681-210 Base)
	55000-009APO	XP95 Red Wall Visual Indicator IP65 with Isolator
	55000-741APO	XP95 Wall Mounted VAD, 8 Metre Range (Red)
	55000-742APO	XP95 Ceiling Mounted VAD, 8 Metre Range (Red)

WALL SOUNDER, VISUAL INDICATOR COMBINATION

B	55000-005APO	XP95 Red Wall Sounder /Indicator IP65 with Isolator
	55000-293APO	XP95 Red Sounder/Indicator with Isolator
	55000-298APO	XP95 Red Weatherproof Sounder/Indicator IP66 with Isolator

LOOP POWERED VADS

C	55000-744APO	Cat W. XP95 Loop Powered VAD 6 Metre (White)
	55000-745APO	Cat C. XP95 Loop Powered VAD 8 Metre (White)

DISCOVERY VOICE RANGE

	58000-010APO	Discovery Red Open Area Voice Sounder with Isolator
	58000-030APO	Discovery Red Open Area Voice Sounder/Indicator with isolator

XP95 INTERFACES

	55000-760APO	XP95 Mini Switch Monitor with Isolator
	55000-845APO	XP95 Zone Monitor with Isolator
	55000-852APO	XP95 Sounder Control Unit with Isolator

INTELLIGENT INTERFACES

D	SA4700-102APO	Intelligent Input/Output Unit
	SA4700-104APO	Intelligent Twin Input/Output Unit
	SA4700-103APO	Intelligent Mains Switching Input/Output Unit
	SA4700-100APO	Intelligent Switch Monitor Unit
	SA6700-100APO	Intelligent Twin Switch Monitor Unit

DIN RAIL INTERFACES

E	SA4700-302APO	Intelligent DIN-Rail Input/Output Unit
	SA4700-300APO	Intelligent DIN-Rail Switch Monitor
	55000-802APO	XP95 Din Rail Dual Isolator
	55000-812APO	XP95 Din Rail Zone Monitor
	55000-182APO	XP95 Din Rail Sounder Control Unit
	29600-239	4 Interface Din Rail Enclosure
	29600-240	Din Rail 10 W Enclosure



All product specifications are supplied by the manufacturer. All manufacturers reserve the right to change specification without notification.



Wireless fire detection.

3-5 years battery life for wireless devices.

Easy to install and suitable for locations where it is difficult to run cables.

APOLLO REACH



A



B



C

LOOP INTERFACES

RW1700-030APO REACH XP95 Loop Interface Module

DETECTORS

A RW1000-600APO REACH Optical Smoke Detector & Base

RW1000-400APO REACH Heat Detector & Base

RW1000-700APO REACH Multi-Sensor Detector (Optical/Heat) & Base

CALL POINTS

RW1900-901APO REACH Manual Call Point

DETECTOR SOUNDER / VAD

RW1300-110APO REACH Sounder Base

B RW1300-210APO REACH Sounder VAD Base (White Flash) (C-3-15)

RW1300-211APO REACH Sounder VAD Base & (Red Flash) (C-3-10)

RW1300-010 REACH AV Base Cap - White

RW1300-020 REACH AV Base Cap - Red

OPEN AREA SOUNDER / VAD

RW1500-110APO REACH Open Area Sounder - White Body

RW1500-120APO REACH Open Area Sounder - Red Body

RW1500-210APO REACH Open Area Sounder VAD Cat.W- White Body (White-Flash) (W-2.5-7)

C RW1500-220APO REACH Open Area Sounder VAD Cat.W- Red Body (White-Flash) (W-2.5-7)

INTERFACE MODULES

RW1700-051APO REACH Input Module

RW1700-052APO REACH Output Module

REMOTE INDICATOR

RW1500-800APO REACH Remote Indicator Module

SURVEY TOOL

RW1800-060APO REACH Survey Kit Lite



All product specifications are supplied by the manufacturer. All manufacturers reserve the right to change specification without notification.

HOCHIKI ESP

ESP PROTOCOL FIRE DETECTION DEVICES

A	ACD-EN	ESP Optical Smoke, Heat & CO Multisensor
	ALN-EN	ESP Optical Smoke Sensor
	ATJ-EN	ESP Heat Sensor
	ACB-EW	ESP Waterproof IP67 Heat Sensor
	B	ACC-EN

ESP BASES (REQUIRED FOR ALL DETECTORS & CEILING MOUNTED DEVICES)

C	YBN-R/3	ESP Sensor Base
	YBN-R/3(SCI)	ESP Combined Sensor/Isolator Base
	YBO-R/3(RED)	ESP Red Base for CHQ-WS2 & CHQ-WSB2
	YBO-R/3(SCI)(RED)	ESP Red Isolator Base for CHQ-WS2 & CHQ-WSB2

ESP CALL POINTS

D	HCP-E(SCI)	ESP Flush Call Point c/w Isolator
	SR3T	Surface Box for HCP-E Call Point
	PS200	Call Point Protective Cover (BS 5839 requirement)
	HCP-W(SCI)	ESP IP65 Call Point c/w Isolator

PROGRAMMER

TCH-B200	ESP Handheld Programmer (Includes PL3 Lead)
----------	---

PHOTOELECTRIC BEAM DETECTOR

ESPFIREBEAMXTRA	ESP Beam Smoke Sensor 7-70 Metres (Reflective)
-----------------	--

ESP SOUNDERS/INDICATORS

	CHQ-WS2	ESP Red Wall Sounder (Requires YBO-R3(RED) Base)
E	CHQ-WSB2/RL	ESP Red Wall Sounder VAD (Requires YBO-R3(RED) Base) Red LEDs
	YBO-BS	ESP Base Sounder (Requires YBN-R3 Base)
F	YBO-BSB2/RL	ESP Base Sounder VAD, Red LEDs (Requires YBN-R3 Base)
	YBO-BSB2/WL	ESP Base Sounder VAD, White LEDs (Requires YBN-R3 Base)
	CHQ-CB(RED)/RL	Loop-Powered Ceiling Beacon EN54-23 (Red Body, Red LEDs)
	CHQ-CB(RED)/WL	Loop-Powered Ceiling Beacon EN54-23 (Red Body, White LEDs)
	CHQ-CB(WHT)/RL	Loop-Powered Ceiling Beacon EN54-23 (White Body, Red LEDs)
G	CHQ-CB(WHT)/WL	Loop-Powered Ceiling Beacon EN54-23 (White Body, White LEDs)
	CHQ-WB/RL	Loop Powered Wall Beacon EN54-23 (White Body, Red LEDs)
	CHQ-AB	ESP Red LED Flashing Indicator (Requires YBN-R3 Base)
	CHQ-AB(AMB)	ESP Amber LED Flashing Indicator (Requires YBN-R3 Base)
	SI-CAP2	Blank Cover Plate for YBO-BS & YBO-BSB
	CHQ-WPK	Weatherproof Kit for CHQ-WS2 & CHQ-WSB

MODULES

CHQ-DRC2(SCI)	ESP Dual Relay Controller c/w Isolator
CHQ-DSC2(SCI)	ESP Dual Sounder Controller c/w Isolator
CHQ-MRC2(SCI)	ESP Mains Switching Relay Controller with Isolator
CHQ-DIM2(SCI)	ESP Dual Input Module c/w Isolator
CHQ-SZM2(SCI)	ESP Single Zone Monitor c/w Isolator
CHQ-DZM(SCI)	ESP Dual Zone Monitor c/w Isolator
CHQ-POM	ESP Powered Output Module
CHQ-SOM	ESP Single Output Module
CHQ-SIM	ESP Single Input Module
CHQ-PCM(SCI)	ESP Plant Control Module (with SCI)

MODULE BOX

CHQ-BACKBOX	ESP Module Deep Back Box
-------------	--------------------------



HOCHIKI ESP DEVICES ARE ALSO AVAILABLE IN WHITE BY ADDING WHT AT THE END OF THE PART NUMBER

NITTAN EVOLUTION PROTOCOL

NITTAN

A



B



C



D



E

PANEL

- A** EVOLUTION-1 Single Loop, Touch Screen Fire Alarm Panel

DEVICES

- B** EV-P Optical Smoke Detector
 EV-DP Dual Optical Smoke Detector
 EV-DPH-A2R Dual Optical Smoke & Rate of Rise Heat Sensor (A2R)
 EV-DPH-CS Dual Optical Smoke & Heat Temp Head Sensor (CS)
 EV-H-A1R Rate of Rise Heat Detector
 EV-H-CS High Temperature Heat Detector 84°C
 EV-PH Multisensor Optical Smoke & A1R Heat Detector
 EV-PYS Optical Smoke Detector c/w In-Built Sounder

DETECTOR BASES/ISOLATORS

- C** UB-6-EV Base - use with EV Analogue Detectors
 EV-B-SCI Detector Base with Short Circuit Isolator
 EV-DIN-SCI DIN Rail Mounting Short Circuit Isolator
 EV-PYSVAD Visual Alarm Base

BASE SOUNDERS

- EV-SDRBASE Loop Powered Sounder Base
 EV-AV2BASE Sounder/Beacon Base

WALL SOUNDERS

- EV-SDR Ceiling/Wall Mounted Sounder
 EV-AV2 Ceiling/Wall Mounted Sounder Beacon
 EV-HIOP-SDR High Output Sounder
D EV-HIOP-SB High Output Sounder Beacon
 EV-HIOP-BCN-SCI High Output Beacon with Isolator

CALL POINTS

- EV-MCP2-SCI-IP24 Reset Call Point with Short Circuit Isolator IP24
 EV-MCP2-SCI-IP67 Waterproof Reset Call Point with Short Circuit Isolator IP67
 CI COVER Hinged Call Point Cover

MODULES

- EV-MINI-IP2 Mini Input Module with Short Circuit Isolator
 EV-IO-420 4-20mA Input/Output Module with SCI & Mains Rated Relay
 EV-OP Output Module
 EV-IP Input Module
E EV-2110 Dual Input/Single Output Module with SCI & Mains Rated Relay
 EV-SCM2 Sounder Control Module (Requires Ext 24V PSU) with SCI
 EV-ZMU2 Zone Monitor Module with SCI (Loop Powered)
 EV-3IO Triple Input/Output Module with SCI and Mains Rated Relay
 SURFACE BOX Plastic Surface Box 45mm Deep for EV Modules

DEVICE PROGRAMMING KIT

- EV-AV2-KIT EV-AD2 Programmer & EV-AVADAPT Universal Lead

REMOTE INDICATORS

- STA-R1 Remote Indicator c/w Text

GENT S-QUAD

GENT
by Honeywell

F



G



H



I

DETECTORS

- F** S4-715 Compact Optical Sensor
 S4-720 Heat Sensor

DETECTOR SOUNDER COMBINATIONS

- S4-770-S Optical Heat Sensor with Sounder
 S4-780S Heat Sensor with Sounder
 S4-771-S Dual Optical Heat Sensor with Sounder
 S4-711-V Dual Optical Heat Sensor with Voice Sounder
G S4-720-V-VAD-HPR Heat Sensor with Voice Sounder & High O/P Red VAD

DETECTOR BASE

- S4-700 Common Base for S-Quad Sensors

CALL POINTS

- H** S4-34800 Vigilon Call Point (Flush)
 S4-34895 Surface Call Point Back Box
 S4-34892-1 Call Point Cover

SOUNDERS & STROBES

- I** S3EP-VAD-HPR-R Loop Driven Sounder/Strobe Red IP55
 S3EP-V-VAD-HPR-R Loop Driven Voice Sounder/Strobe Red 100dB IP55

We can supply the full range of Gent products. Please call for prices.

All product specifications are supplied by the manufacturer. All manufacturers reserve the right to change specification without notification.

NOTIFIER

DETECTION DEVICES

A	NFXI-OPT	Notifier Analogue Smoke Detector
	NFXI-SMT2	Notifier Analogue Multisensor
	NFXI-SMT3	Notifier Analogue Smoke/Heat/IR Multisensor
B	NFXI-TDIFF	Notifier Analogue Rate of Rise Heat Detector 58c A1R
	NFXI-TFIX58	Notifier Analogue Fixed Temperature Heat Detector 58c
	NFXI-TFIX78	Notifier Analogue Fixed Temperature Heat Detector 78c

BASE

C	B501AP	Notifier Analogue Detector Base
	M200E-SMB	Notifier Analogue Surface Mounting Box

CALL POINT

D	M5A-RP02FF-K013-01	Notifier Flush Analogue Call Point. Glass
	W5A-RP01SGK01301	Notifier Weatherproof Analogue Call Point IP67
D	W5A-RP02SG-01	Notifier Weatherproof Analogue Call Point IP67 with Isolator
	PS200	Hinged Call Point Cover

BASE SOUNDER/BEACONS

NFXI-BS-W	Notifier White Sounder Base (Requires B501AP Base)
NFXI-DSF-WC	Notifier White Sounder/Beacon Base (Requires B501AP Base)
NFXI-BF-WC	Notifier Clear Beacon Base (Requires B501AP Base)

WALL SOUNDERS/BEACONS

E	W50-PR-I02	Notifier Wall Mounted Red Loop Sounder (Requires B501AP Base)
	NFXI-WS-W	Notifier Wall Mounted White Loop Sounder (Requires B501AP Base)
	NFXI-WSF-RR	Notifier Wall Mounted Red Loop Sounder/Beacon (Requires B501AP Base)
	NFXI-WF-WC	Notifier Wall Mounted Loop Beacon (Requires B501AP Base)

INTERFACES

F	M701	Notifier Output Module (Requires M200E-SMB Box)
	M701-240	Notifier Output Unit 240V (Requires M200E-SMB Box)
	M710	Notifier Input Module with Isolator (Requires M200E-SMB Box)
	M710-CZR	Notifier Conventional Zone Monitor (Requires M200E-SMB Box)
	M720	Notifier Dual Input Monitor Module (Requires M200E-SMB Box)
	M721	Notifier Dual Input, Single Output Module (Requires M200E-SMB Box)



ZITON

DETECTORS

G	ZP730-2P	Ziton Optical Smoke Detector (Polar White)
	ZP720-3P	Ziton Heat Detector Compatible with V3.0 Software (Polar White)
	ZP732-2P	Ziton Combined Smoke/Heat (Polar White)

DETECTOR BASE

H	ZP7-SB1-P	Ziton Standard Base (Polar White)
----------	-----------	-----------------------------------

CALL POINTS

ZP785-3	Ziton Flush Call Point
ZP787-3	Ziton Waterproof Call Point
PS200	Hinged Call Point Cover

PLATFORM SOUNDERS & BEACONS

I	ZP755B-2P	Ziton Sounder Base (Polar White) (Requires SPB-2P)
	ZP755BV-4P	Ziton Sounder Beacon Base (Polar White) (Requires SPB-2P)
	SPB-2P	Ziton Base for ZP755B-2P Sounder (Polar White)
	ZP755-COV-P	Ziton Blank Cover for ZP755 Sounder or Beacon (Polar White)

SOUNDERS & BEACONS

ZP755HA-2R	Ziton Horn Sounder Red (Requires SPB-2R Base)
ZP755HAV-2R	Ziton Horn Sounder Beacon Red (Requires SPB-2R Base)
SPB-2R	Ziton Red Base for ZP755HA-2R Sounder

IP65 SOUNDER & BEACON

J	ZP755W-2R	Ziton Weatherproof Red Horn Sounder
J	ZP755WW-2R	Ziton Weatherproof Red Horn Sounder/Beacon

INTERFACES

A45E-2	Ziton Mini Input Interface
A50E-2	Ziton Mini Relay Output Unit
A51E-1	Ziton Mini Relay Unit, Mains Switching
SMB-DIN1	Ziton Surface Box for "A" Series Relays



All product specifications are supplied by the manufacturer. All manufacturers reserve the right to change specification without notification.

FIKE CIE-A-200

Fike



A

CIE-A-200 PANEL & ACCESSORIES

A	520-0001	CIE-A-200 Single Loop Fire Alarm Panel
	CIA-A-400	CIE-A-400 Two Loop Fire Alarm Panel
	520-0010	CIE-A-200 Repeater Panel
	540-0030	CIE-A-200/ CIE-A-400 Mount Bezel
	540-0020	CIE-A-200/CIE-A-400 Expansion Box
	45-0014-0024	CIE-A-200 Battery leads & Spares Pack
	520-0020	CIE-A-200 Software Licence inc Training
	09-0026	CIE-A-200 Spare Key

FIKE ASD

Fike



B

ASD ADDRESABLE DETECTORS

	205-0003	ASD Detector, Inc Base
B	205-0001	ASD Detector with Sounder, Inc Base
	205-0012	ASD Detector with Sounder & Strobe, Inc Base
	25-0046-201	ASD Detector Head Removal Tool

HAES ESPRIT ADDRESSABLE PANELS

HAES

ESPRIT ADDRESSABLE PANELS - APOLLO PROTOCOL

	ESA-1006	ESPRIT 1-2L
	ESA-1007	ESPRIT 1-4L
	ESA-2001	ESPRIT Network Repeater
	ESA-3006	ESPRIT Single Loop Extension Card
	ESA-3002	ESPRIT Network Card PCB

Extendable up to Two Loop Circuits and with up to 240 Addresses per Loop, when using Soteria Devices.

The New Apollo Addressable Panel from Haes



NEW G-ONE FIRE ALARM PANEL

The G-One is a versatile compact addressable Fire Alarm Control Panel which can be surface or recess mounted. The powerful cause and effect programming capabilities along with enhanced system diagnostics performance makes this control panel suitable for a wide range of applications from small to large buildings or sites with complex multiple areas.

GLOBAL FIRE EQUIPMENT

G-ONE PANEL

A	G-ONE	Single loop panel
----------	-------	-------------------

OCTO + PANELS

B	OCTOPLUS-2L	Octo + 2 Loop Addressable Panel
	OCTOPLUS-4L	Octo + 4 Loop Addressable Panel

GEKKO PANELS

C	GEKKO-2	Gekko 2 Loop Addressable Panel
D	CHAMELEON-MINI-REP	Gekko Mini Repeater Panel



GLOBAL FIRE EQUIPMENT

ADDRESSABLE DETECTORS - AVAILABLE IN WHITE AND BLACK

E	ZEOS-AD-S	ZEOS - Addressable Optical Smoke Detector with dip switch addressing
	ZEOS-AD-H	ZEOS - Addressable Heat Detector with Dip Switch Addressing
	ZEOS-DETECTOR-BASE	ZEOS Detector Base

ADDRESSABLE CALL POINTS

F	GFE-MCPE-A	GFE Addressable Manual Call Point - with Built-in Hinged Cover
	GFE-MCPE-AI-IP67	GFE Addressable Manual Call Point with Isolator - IP67 - with Built-in Hinged Cover

ADDRESSABLE SOUNDERS - AVAILABLE IN WHITE AND RED

	VALKYRIE-AS	VALKYRIE - Addressable Wall Mount Sounder - Red or White
	VALKYRIE-ASB	VALKYRIE - Addressable Wall Mount Sounder / Beacon - Red or White
	VALKYRIE-ASBI-IP65	VALKYRIE - Addressable Wall Mount Sounder / Beacon IP65 - Red
G	VALKYRIE-AB	VALKYRIE - Addressable Beacon - Red or White
	VULCAN2-ASI	VULCAN 2 - Addressable Base Sounder c/w isolator
	VULCAN2-ASBI	VULCAN 2 - Addressable Base Sounder / Beacon, c/w isolator
	VULCAN2-ABI	VULCAN 2 - Addressable Base Beacon
	VULCAN2-LID	LID for Vulcan when not used with Detector - Transparent or White

ADDRESSABLE INTERFACES

	3 I/O-PLUS-1CH	Addressable Interface 1 Channel (2 & 3 Channel versions available)
	MAINS I/O	Addressable Interface - Mains
	ZMU	Addressable Zone Monitor
	Sprinkler Switch	Addressable Sprinkler Switch Module



Global Fire Equipment UK's entire new range of products now available

All product specifications are supplied by the manufacturer. All manufacturers reserve the right to change specification without notification.

For more information or to place an order:

Phone: 01425 658239

Fax: 01425 658241

Email: sales@etectionsupplies.co.uk



A



B



C



D



E



F



G



SYSTEM SENSOR

SENSOR DETECTION DEVICES

A	22051E-26	Optical Smoke Sensor, White. Requires B501AP base
	22051TE-26	Multi-sensor Combined Optical Smoke Sensor and Thermal Sensor in a Single Housing, White, Requires B501AP Base
	52051E-26	Heat Sensor, 58°C, White. Type A1R. Requires B501AP base
B	52051RE-26	Heat Sensor, 58°C and Rate of Rise, White. Type A1R. Requires B501AP Base
	52051HTE-26	Heat High Temperature Sensor, 78°C, White. Type BS. Requires B501AP Base

DETECTION DEVICES WITH ISOLATOR

	22051EI-26	Optical Smoke Sensor c/w Isolator, White. Requires B501AP Base
	22051TEI-26	Multi-sensor Combined Optical Smoke Sensor and Thermal Sensor c/w Isolator in a Single Housing, White, Requires B501AP Base
	52051EI-26	Heat sensor, 58°C and Rate of Rise c/w Isolator, White. Type A1R. Requires B501AP Base

BASES

C	B501AP	Analogue Sensor Base with SEMS Screw Connections for Isolated and Non-isolated Detectors and Address Identification Label
	B524IEFT-1	Deep Analogue Sensor Base with Built-in FET Isolator with SEMS Screw Connections and Address Identification Label

CALL POINTS

	M5A-RP01FG-X999-03	Addressable Manual Call Point. Glass Element
	M5A-RP01FF-X999-03	Addressable Manual Call Point. Flexible Element
	W5A-RP01SG-K013-01	Addressable Waterproof Call Point, IP67

CALL POINTS WITH ISOLATOR

	M5A-RP02FF-X999-03	Addressable Manual Call Point with Built-in Isolator. Flexible Element
--	--------------------	--

BASE SOUNDERS

	BSO-PP-N00	Addressable Loop Powered Base Sounder, EN54-3 Approved. White
	BSO-PP-I00	Addressable Loop Powered Base Sounder, EN54-3 Approved. White. Built-in Loop Isolation

BASE SOUNDER BEACONS

	BRS-PC-I00	Loop Powered EN54-23 C Category - Standard Performance Detector Base Sounder Strobe. Red Flash, Pure White Body, Clear Lens
	BRH-PC-I00	Loop Powered EN54-23 C Category - High Performance Detector Base Sounder Strobe. Red Flash, Pure White Body, Clear Lens
	BGL-PC-I00	Loop Powered EN54-23 C Category - Base Sounder Strobe. Red Flash, Pure White Body, Clear Lens
	DSS-PC-N00	Loop Powered EN54-23 Open Category Detector Base Sounder Strobe in Pure White with Clear Lens and Red Flash. Non-isolated version. Features B501AP Base for fast and simple installation for System Sensor Detectors and a choice of sound output levels and tones selectable from the device or panel.
	DSS-PC-I00	Loop Powered EN54-23 Open Category Detector Base Sounder Strobe in Pure White with Clear Lens and Red Flash. Isolated version. Features B501AP Base for fast and simple installation for System Sensor Detectors and a choice of sound output levels and tones selectable from the device or panel.
	IBS-LIDPW	Pure White cover plate for base sounders. Pack of 10.

WALL SOUNDERS/STROBES

D	WSO-PR-N00	Wall Sounder - Wall Mounted, Addressable, Loop Powered Sounder, EN54-3 Approved, Red
	WSO-PP-N00	Wall Sounder - Wall Mounted, Addressable, Loop Powered Sounder, EN54-3 Approved, White
	WSS-PR-N00	Wall Sounder - Addressable Loop Powered Base Sounder, EN54-3 Approved, with Visual Indicating Device (VID), White Body, Clear Lens with Red Flash. Not Isolated. This product is not approved to EN54-23 (Visual Alarm Device) and must not be used as a visual alarm device to provide a primary warning notification of fire.
	WST-PC-N00	Wall VAD - Wall Mounted, Addressable Loop Powered EN54-23 O Class Compliant (W-1.68-1.68) Clear Lens with Red Flash. Not Isolated.

WALL SOUNDERS/STROBES WITH ISOLATOR

	WSO-PR-I00	Wall Sounder - Wall Mounted, Addressable, Loop Powered Sounder, EN54-3 Approved, Red with Built-in Loop Isolation
	WSS-PC-N00	Wall Sounder VAD - Wall Mounted, Addressable, Loop Powered Sounder, EN54-3 Approved, with Visual Alarm Device (VAD), EN54-23 O Class Compliant (W-1.9-1.9). Clear Lens with Red Flash. Not Isolated
E	WSS-PR-I00	Wall Sounder VID - Wall Mounted, Addressable, Loop Powered Sounder, EN54-3 Approved, with Visual Indicating Device (VID), Red Lens. Built-in Loop Isolation. This product is not approved to EN54-23 (Visual Alarm Device) and must not be used as a visual alarm device to provide a primary warning notification of fire.

SOUNDER/STROBE BASE OPTIONS

	BPW	Addressable Deep Base for Detector and AV, White
	BRR	Addressable Deep Base for Detector and AV, Red
	WRR	Addressable Sealed Deep Base for Detector and AV, Red

MODULES

	M210EA	Single Input Monitor Module. Requires M200E-SMB for Surface Mounting or M200E-DIN for Mounting to DIN Rails.
	M220EA	Dual Input or Monitor Module. Requires M200E-SMB for Surface Mounting or M200E-DIN for Mounting to DIN rails.
	M221EA	Dual Input and Single Control Output Combination Module. Requires M200E-SMB for Surface Mounting or M200E-DIN for Mounting to DIN Rails.
F	M201EA	Output Control Module. Requires M200E-SMB for Surface Mounting or M200E-DIN for Mounting to DIN Rails.
	M201E-240	Output Control Module. 240V AC Relay Contact Rating, Complete with Surface Enclosure.
	M210E-CZR	System Sensor Zone Monitor Module (Requires SMB500 Box)

MODULE MOUNTING BOX

G	M200E-SMB	Surface Mounting Box for M2xx Series Modules.
---	-----------	---

All product specifications are supplied by the manufacturer. All manufacturers reserve the right to change specification without notification.

EATON FIRE SYSTEMS



ADDRESSABLE ALARMS AND BEACONS

A	CAS380	Addressable Sounder Base
	CAS381	Addressable Wall Sounder
	CAS381WP	Addressable Wall Sounder, Weatherproof
	CASB383	Addressable Wall Sounder Beacon
	CASB383-WP	Addressable Wall Sounder Beacon, Weatherproof
	CASBB384	Addressable Sounder Beacon Base
	CASC	Sounder Cover Plates (pack of 5)
	CAB382	Addressable Led Beacon
	MASC	Sounder Cover Plates (pack of 5)



ADDRESSABLE ALARMS AND BEACONS (VAD)

B	CAB482CS	Addressable Ceiling VAD (Red Plastic, Rad Flash, Shallow Base)
	CAB482WD	Addressable Wall VAD (Red Plastic, Red Flash, Deep Base)
	CAB482WS	Addressable Wall VAD (Red Plastic, Red Flash, Shallow Base)
	CAB492CS	Addressable Ceiling VAD (Red Plastic, White Flash, Shallow Base)
	CAB492WD	Addressable Wall VAD (Red Plastic, White Flash, Deep Base)
	CAB492WS	Addressable Wall VAD (Red Plastic, White Flash, Shallow Base)
	CASBB394	Addressable Sounder VAD Base (Open Class, White Flash)
	CASB393	Addressable Wall Sounder VAD (Red Plastic, White Flash, Open Class)
	CASB393WP	Addressable Wall Sounder VAD (Red Plastic, White Flash, WP, Open Class)
	CASB483	Addressable Wall Sounder VAD (Red Plastic, Red Flash)
	CASB483WP	Addressable Wall Sounder VAD (Red Plastic, Red Flash, WP)
	CASB493	Addressable Wall Sounder VAD (Red Plastic, White Flash)
	CASB493WP	Addressable Wall Sounder VAD (Red Plastic, White Flash, WP)



ADDRESSABLE INSTALLATION ACCESSORIES

C	CF800PROG	Addressable Device Programmer
	LP800KIT	Addressable Loop Tester Kit
	USBINT2	Addressable Panel/Interface Programmer

ADDRESSABLE INTERFACES

	CIOF-7273	Addressable Door Release Module
	MARDF6	Auxiliary Output Module
	CMIO353	Addressable 230V Relay I/O Unit
	CZMU352	Addressable Zone Monitor Unit
	MCIM	Addressable Micro Single Channel Input Unit
	MCOM	Addressable Micro Single Channel Output Unit



ADDRESSABLE CONTROL PANELS

	CF2000	Addressable 2 Loop Control Panel, Standalone
D	CF30001G	Addressable 1 Loop Control Panel
	CF30002G	Addressable 2 Loop Control Panel
	CF30002GNC	Addressable 2 Loop Control Panel c/w Network Card
	CF30004G	Addressable 4 Loop Control Panel
	CF30004GNC	Addressable 4 Loop Control Panel c/w Network Card



ADDRESSABLE REPEATER PANELS

	CTPR3000	Addressable Touch Screen Repeater
E	CF3000PRG	Addressable Passive Repeater

ADDRESSABLE DETECTORS : BASES

	CAB300	Addressable Detector Base
--	--------	---------------------------

ADDRESSABLE DETECTORS : BASES

F	CAP320	Addressable Optical Smoke Sensor
	CAPT340	Addressable Optical - Thermal Sensor
	CAH330	Addressable Multi-Mode Heat Sensor
	MRIAD	Addressable Remote Indicator



ADDRESSABLE CALL POINTS

	CBG370S	Addressable Manual Call Point
G	CBG370WP	Addressable Manual Call Point, Weatherproof



All product specifications are supplied by the manufacturer. All manufacturers reserve the right to change specification without notification.

YUASA SEALED LEAD ACID BATTERIES



A



B



C



D



E



F



G



H

NP 6V RANGE

A	NP1-6	SLA Battery 6V 1Ah	L51 x W43 x H54	0.25Kg
	NP1.2-6	SLA Battery 6V 1.2Ah	L97 x W25 x H55	0.31Kg
	NP2.8-6	SLA Battery 6V 2.8Ah	L134 x W34 x H64	0.57Kg
	NP4-6	SLA Battery 6V 4Ah	L70 x W47 x H105	0.85Kg
	NP7-6	SLA Battery 6V 7Ah	L151 x W34 x H97	1.35Kg
	NP12-6	SLA Battery 6V 12Ah	L151 x W50 x H97	2.10Kg

NP 12V RANGE

	NP1.2-12	SLA Battery 12V 1.2Ah	L97 x W48 x H55	0.57Kg
B	NP2.1-12	SLA Battery 12V 2.1Ah	L178 x W34 x H65	0.90Kg
	NP3.2-12	SLA Battery 12V 3.2Ah	L134 x W67 x H94	2.10Kg
	NP4-12	SLA Battery 12V 4Ah	L90 x W70 x H106	1.70Kg
C	NP7-12	SLA Battery 12V 7Ah	L151 x W65 x H98	2.65Kg
	NP12-12	SLA Battery 12V 12Ah	L151 x W98 x H98	4Kg
D	NP17-12	SLA Battery 12V 17Ah	L181 x W75 H167	6.20Kg
	NP24-12	SLA Battery 12V 24Ah	L166 x W175 x H125	9Kg
	NP38-12	SLA Battery 12V 38Ah	L197 x W164 x H170	14.20Kg
	NP65-12	SLA Battery 12V 65Ah	L350 x W166 x H174	22.80Kg

YUCEL RANGE

	YUCEL1.2-12	SLA Battery 12V 1.2Ah	L97 x W48 x H55	0.57Kg
	YUCEL2.1-12	SLA Battery 12V 2.1Ah	L178 x W34 x H65	0.90Kg
	YUCEL3.2-12	SLA Battery 12V 3.2Ah	L134 x W67 x H94	2.10Kg
	YUCEL7-12	SLA Battery 12V 7Ah	L151 x W65 H98	2.65Kg
E	YUCEL12-12	SLA Battery 12V 12Ah	L151 x W98 x H98	4Kg
	YUCEL17-12	SLA Battery 12V 17Ah	L181 x W75 x H167	6.20Kg
F	YUCEL24-12	SLA Battery 12V 24Ah	L166 x W175 x H125	9Kg
	YUCEL38-12	SLA Battery 12V 38Ah	L197 x W164 x H170	14.20Kg
	YUCEL65-12	SLA Battery 12V 65Ah	L350 x W166 x H174	22.80Kg

NPL LONG LIFE

	NPL24-12	SLA Battery 12V 24Ah	L166 x W175 x H125	9Kg
G	NPL38-12	SLA Battery 12V 38Ah	L197 x W165 x H170	14Kg
	NPL65-12	SLA Battery 12V 65Ah	L350 x W166 x H174	23Kg
	NPL78-12ISR	SLA Battery 12V 78Ah	L380 x W166 x H174	27.50Kg
	NPL100-12	SLA Battery 12V 100Ah	L407 x W172 x H240	39Kg

EN ENDURANCE RANGE - 10 YEAR DESIGN LIFE

	EN100-4	Endurance Battery 4V 100Ah	L200 x W208 x H238	17.5Kg
	EN160-4	Endurance Battery 4V 160Ah	L206 x W210 x H240	24Kg
	EN80-6	Endurance Battery 6V 80Ah	L305 x W210 x H240	38Kg
	EN100-6	Endurance Battery 6V 100Ah	L200 x W208 x H238	23Kg
H	EN160-6	Endurance Battery 6V 160Ah	L305 x W210 x H240	35Kg

DURACELL ALKALINE INDUSTRIAL BATTERIES

DURACELL INDUSTRIAL

I	ID1500/10	AA Size Pack of 10
	ID2400/10	AAA Size Pack of 10
	ID1400/10	C Size Pack of 10
	ID1300/10	D Size Pack of 10
	ID1604/10	9V Size Pack of 10

LITHIUM

	CR2016B2	3V Lithium Battery (Blister of 2)
	CR2032	3V Lithium Battery (Blister of 2)
	CR123	CR123ULTRA 3V Lithium Battery (Blister of 2)



I

All product specifications are supplied by the manufacturer. All manufacturers reserve the right to change specification without notification.

Ring the alarm

If you are not using Europe's number one standby battery.



Effective security and fire systems depend on reliable backup power.

As European market leader for over 30 years and the number one choice for reliability, quality and performance, you can always trust Yuasa standby batteries to perform at the critical moment.

Don't take risks with your backup power.
Demand the best standby battery... Demand Yuasa!

Discover more at www.yuasaeurope.com

A  Group Company



YUASA
BATTERY

C-TEC EN54-4 COMPLIANT 12 & 24V DC POWER SUPPLIES



PLASTIC ENCLOSURE 24V

BF560-24 1.5 Amp PSU 24V DC EN54 Plastic Enclosure W380 x H235 x D96 Max Batt Size 2 x 3.2Ah

METAL ENCLOSURE 24V

BF562-1 1.5 Amp PSU 24V DC EN54 Metal Enclosure W404 x H404 x D110 Max Batt Size 2 x 17Ah

BF562-3 3 Amp PSU 24V DC EN54 Metal Enclosure W404 x H404 x D110 Max Batt Size 2 x 17Ah

BF562-5 5 Amp PSU 24V DC EN54 Metal Enclosure W404 x H404 x D110 Max Batt Size 2 x 17Ah

PLASTIC ENCLOSURE 12V

BF560-12 2 Amp PSU 12V DC EN54 Plastic Enclosure W380 x H235h x D96 Max Batt Size 2 x 7Ah

ELMDENE POWER SUPPLIES INCLUDING EN54 APPROVED



EN54-4 APPROVED 24V DC SWITCHMODE POWER SUPPLIES METAL ENCLOSURES

STX2401-T 1.2 Amp (Total Power) EN54-4 PSU 24V DC H300 x W240 x D60 Max Batt Size 2 x 3.2Ah

STX2401-C 1.5 Amp (Total Power) EN54-4 PSU 24V DC H275 x W330 x D80 Max Batt Size 2 x 7Ah

STX2402-C 2.5 Amp (Total Power) EN54-4 PSU 24V DC H275 x W330 x D80 Max Batt Size 2 x 7Ah

STX2402-E 2.5 Amp (Total Power) EN54-4 PSU 24V DC H420 x W400 x D80 Max Batt Size 2 x 17Ah

STX2405-C 5.8 Amp (Total Power) EN54-4 PSU 24V DC H275 x W330 x D80 Max Batt Size 2 x 7Ah

STX2405-E 5.8 Amp (Total Power) EN54-4 PSU 24V DC H420 x W400 x D80 Max Batt Size 2 x 17Ah

STX2410-E 10.7 Amp (Total Power) EN54-4 PSU 24V DC H420 x W400 x D80 Max Batt Size 2 x 17Ah

STX2410-H 10.7 Amp (Total Power) EN54-4 PSU 24V DC H420 x W420 x D180 Max Batt Size 2 x 38Ah

BATTERY CABINET

BATT-BOX-65 Battery Enclosure W465 x H534 x D270 for 2 12V 65Ah Batteries (with 3m Battery Leads)

GLOBAL FIRE EQUIPMENT POWER SUPPLIES EN54 APPROVED



PLASTIC ENCLOSURE 24V

ORION-BCM 1.7Amp PSU 24V DC EN54 with Battery Charger H404 X W273 X D142 Max Batt Size 2 x 7Ah

HAYDON POWER SUPPLIES



METAL ENCLOSURE 24V

HAY-PSU24V1ASMSP 1 Amp Door Retainer PSU 24V DC with Fire Input Relay

HAY-PSU24V2ASMSP 2 Amp Door Retainer PSU 24V DC with Fire Input Relay

HAY-PSU24V4ASMSP 4 Amp Door Retainer PSU 24V DC with Fire Input Relay

All product specifications are supplied by the manufacturer. All manufacturers reserve the right to change specification without notification.

KENTEC EN54-4 COMPLIANT 24V DC POWER SUPPLIES

EN54-4 COMPLIANT 24V DC

	K2525003	2.5 Amp PSU 24V DC EN54 Metal Enclosure W500 x H355 x D117
A	K25250M2	2.5 Amp PSU 24V DC EN54 Metal Enclosure W385 x H310 x D90
	K25250M3	2.5 Amp PSU 24V DC EN54 Metal Enclosure W385 x H520 x D110
	K2540003	5.25 Amp PSU 24V DC EN54 Metal Enclosure W500 x H355 x D117
	K2540015	5.25 Amp PSU 24V DC EN54 Metal Enclosure W500 x H460 x D190
	K25400M3	5.25 Amp PSU 24V DC EN54 Metal Enclosure W385 x H520 x D110
	K2580003	10.25 Amp PSU 24V DC EN54 Metal Enclosure W500 x H355 x D117
	K2580015	10.25 Amp PSU 24V DC EN54 Metal Enclosure W500 x H460 x D190
	K25800D3	10.25 Amp PSU 24V DC EN54 Metal Enclosure W385 x H520 x D200
	K738	Dual Power Output Board



EN54-4 24V DC Power Supplies for fire alarm systems:- If supply is used to power a fire detection panel or alarm devices associated with the fire system, a Dual Power Output Board will be required for compliance with EN54-4 clause 6.4 Power Supply Interface. Part Number K738. Dual Power Output Board.

24V DC TRANSFORMER RECTIFIERS

C-TEC

B	BF375PE	250mA 24V DC Transformer Rectifier on 2 Gang Plate
---	---------	--

ELMDENE

	TRS-1	1 Amp 24V DC Transformer Rectifier W185 x H200 x D55
	TR2	2 Amp 24V DC Transformer Rectifier W230 x H200 x D80
	TR4	4 Amp 24V DC Transformer Rectifier W230 x H200 x D80

VIMPEX - ALSO AVAILABLE IN RED

C	10-3010WFG-S	Single Gang 12/24V DC Power Supply Unit, White, Flush Mounted
	10-3010WSG-S	Single Gang 12/24V DC Power Supply Unit, White, Surface Mounted

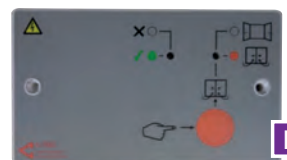

Suitable for use with 24 volt door retainers or other devices where a maintained supply is not required in a mains failure condition. NOT SUITABLE FOR CHARGING BATTERIES



BATTERY BOXES

BATTERY BOX TO MATCH SYNCRO STYLING

K1620203 Battery Box Max 18ah

K1619911 Battery Box Max 24ah

BATTERY BOX TO MATCH SIGMA STYLING

K16100M2 Battery Box Max 7ah

K16100M3 Battery Box Max 18ah

D	K16100D3	Battery Box Max 38ah
---	----------	----------------------



ACOUSTICALLY TRIGGERED DOOR RETAINERS & PILLOW ALARM

AGRIPPA

E	3-80-0060	Agrippa Battery Powered Door Retainer (Includes Batteries)
	3-80-0070	Agrippa Battery Powered Overhead Door Closer (Includes Batteries)
F	3-80-0045	Agrippa Pillow Fire Alarm
	2-34-9056-S002	Agrippa Floor Mounting Bracket

DORGARD

G	DORGARD-SMARTSND	Dorgard Smart Sound, Black
	DORGARD FLOORPLT	Dorgard Floor plate

DEAFGUARD

	DEAFGUARD	Deafguard Wireless Pillow Vibration Unit
--	-----------	--



All product specifications are supplied by the manufacturer. All manufacturers reserve the right to change specification without notification.

ARROW ELECTROMAGNETIC DOOR CLOSERS - CARE HOMES, HOSPITALS, SCHOOLS

The A624 range of door closers are a multi-functional fire door closer with a 24V magnetic holding device incorporated within the body which can be configured to hold open at 90° or operate in "Swing Free Mode", i.e. behave as if no hydraulic closer were fitted and left open at any convenient angle. When the power is switched off or interrupted by a signal from a fire alarm system, the door will then fully close.

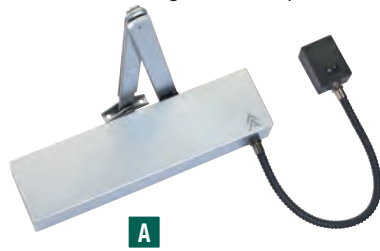

24V DC HOLD OPEN / SWING FREE DOOR CLOSERS

- A A624SILVER Overhead Hold Open/Swing Free Door Control, Silver
- A624BRASS Overhead Hold Open/Swing Free Door Control, Brass with Black Arms

24V DC HOLD OPEN / SWING FREE DOOR CLOSERS - FLOWLINE COVER

- A624 Coloured Supplied with Flowline Cover & Black Arms as Standard
- A624 Plated Available in Polished or Satin Brass, Polished or Satin Nickel, or Polished Anodised Aluminium
- A624 Stainless Available in Satin or Polished Stainless Steel

MANUAL DOOR CLOSER

- A325VP Manual Door Closer, Satin Stainless Steel c/w matching arm

EXIDOR CARE HOME DOOR CLOSERS

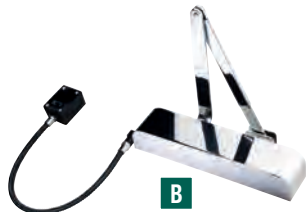

GUARDIAN - ANTI SLAM FINGER PROTECTION

- B 9880R-SILVER Guardian Closer with Elegant Radius Cover and Matching Arm H60 x W290 x D53
- 9880SQ-SILVER Guardian Closer with Sylish Square Cover and Matching Arm H60 x W290 x D53
- 4880-SILVER Guardian Closer with Narrow Profile Slide Front and Matching Arm H48 x W269 x D52

NOTE also available in Satin Stainless Steel, Polished Stainless Steel & Polished Brass. Other finishes available on request.

MAGNETIC & HYDRAULIC DOOR RETAINERS



WALL MOUNTED DOOR RETAINERS

- C 3-59-03-CNQ24 Conquest Door Retainer 24V DC Surface or Flush, Metal 50mA
- 3-59-03-CNQ230 Conquest Door Retainer 230V AC Surface or Flush, Metal
- 3-87-0370 Type 87 Door Retainer 24V DC ABS Fire Resistant Box 45mA
- 3-87-0371 Type 87 Door Retainer 230V AC ABS Fire Resistant Box
- 3-87-0551 Type 87 50kg Door Retainer 24V DC 90mA

- D FMB-CONQ Conquest Floor Mounting Bracket

FLOOR MOUNTED DOOR RETAINERS

- E 3-84-0301 Floor Mounted 20kg Door Retainer 24V DC Cast Metal Housing 45mA
- 3-84-0501 Floor Mounted 50kg Door Retainer 24V DC Cast Metal Housing 90mA

UNIVERSAL DOOR RETAINERS

- F 3-79-05200 Universal Door Retainer 50Kg 24V DC 250mm Long 55mA
- 3-79-05300 Universal Door Retainer 50Kg 24V DC 350mm Long 55mA
- 3-79-05500 Universal Door Retainer 50Kg 24V DC 500mm Long 55mA
- 3-79-06300 Universal Door Retainer 100Kg 24V DC 350mm long 90mA

ACCESSORIES

- 2-31-0310-U005 Replacement White Swivel Keeper Plate
- DR-RB Sealing Ring for Standard Keeper Plate
- 2-31-0307-N237 Metal Low Profile Keeper Plate
- 2-31CHPLATE Keeper & 1 Metre Chain Plate

SPECIAL FINISH VERSIONS

- 3-59-0301-M001 Flush Stainless Steel Single Gang Door Retainer 24V DC
- 2-34-0424-M095 Stainless Surface Mount Kit
- 3-59-0301-E001 Flush Brass Single Gang Door Retainer 24V DC
- 2-34-0424-E091 Brass Surface Mount Kit
- G 3-59-0301-C001 Flush Bright Chrome Single Gang Door Retainer 24V DC
- 3-59-0302-C001 Flush Bright Chrome Single Gang Door Retainer 240V AC
- 2-34-0424-C091 Bright Chrome Surface Mount Kit

IP65 DOOR RETAINERS

- 3-59-0801-G006 Weatherproof IP65 24V DC 120Kg Door Retainer

SALAMANDER WIRELESS SYSTEM

- 3-80-0012 Salamander Wireless Door Retainer Controller
- 3-80-0013 Salamander Wireless Door Retainer
- 3-80-0014 Salamander Wireless Signal Booster
- 3-80-0007 Salamander Wireless Survey/Range Finder Kit
- 3-80-0050 Salamander Wireless Overhead Door Closer (Right)
- 3-80-0051 Salamander Wireless Overhead Door Closer (Left)

FLOOR BRACKET

- 2-34-9056-S002 Floor Bracket for Salamander Door Retainer



MAGNETIC DOOR LOCKS

MAGNETIC DOOR LOCKS

A	AEM10001	Slimline Unmonitored Magnet
	AEMBR089	Z&L Bracket Set for Slimline Magnet
B	AEM10010	Standard Single Magnet Unmonitored
	AEM10020	Standard Single Magnet Monitored
C	AEMBR026	Z&L Bracket Set for Standard Magnet
	AEM10060	Standard Double Magnet Unmonitored
	AEMGATE-FS	External Magnet Side/Face Fix
	AEMBR046	Z Bracket for External Magnet

MORTICE LOCK RELEASES

D	ADCN512G	Fail Safe Mortice Lock Release, 12V DC
	ADCN524G	Fail Locked Mortice Lock Release, 24V DC
E	AL900	Mortice Electric Release 12V/24V DC

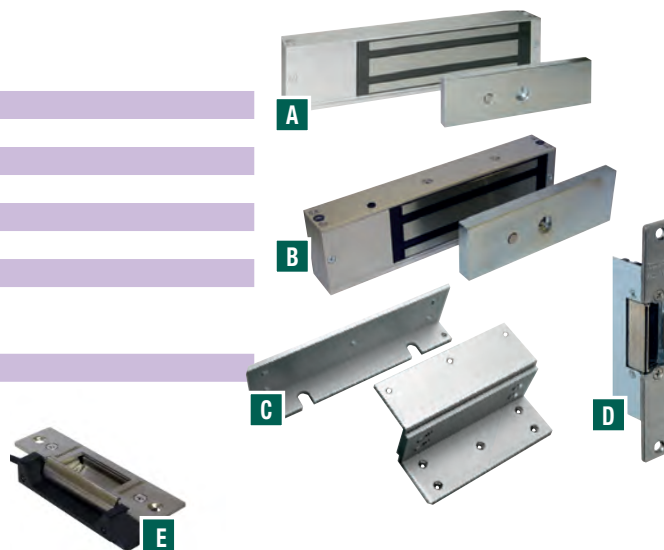

STAINLESS STEEL NOTOUCH BUTTONS

F	NT-SS001-EN	Stainless Steel Contactless Button - Slim Mulion Mount - EXIT Label - Form "C" Dry Contact
	NT-SS002-EN	Stainless Steel Contactless Button - Slim Mulion Mount - OPEN Label - Form "C" Dry Contact
	NT-SS301-EN	Stainless Steel Contactless Button - Single Gang - EXIT Label - Form "C" Dry Contact
	NT-SS302-EN	Stainless Steel Contactless Button - Single Gang - OPEN Label - Form "C" Dry Contact
	NT-CA300-EN	Cast Aluminium Contactless Button - Single Gang - Tri Label - Form "C" Dry Contact
	KIT-BB3SS	45mm Back Box Kit for NT-SS30*-EN
	KIT-BB3CA	45mm Back Box Kit for NT-CA300-EN



ANCILLARY PRODUCTS

DOOR RELEASE KEYPADS

G	ACT5	IP65 Keypad
H	APX16PROX	IP65 Keypad & Proximity Reader
	APX-14T	IP68 Standalone Key Pad with Bluetooth

PUSH BUTTON DOOR RELEASE SWITCHES

I	AEB1NR	Surface White Plastic Exit Button
J	AEB26	Surface Stainless Steel Exit Button
K	AEB514	Touch Sensitive Button, Black with Blue Led
	AEB516	Touch Sensitive Button, White with Blue Led
	AEB507/B	IP65 Press to Exit Switch Stainless Steel with Green Dome & Switch
	AEB504/B	IP65 Press to Exit Switch Stainless Steel with 22mm Button & Back Box
L	AEB6	Flush Stainless Steel Green Dome Exit Button
	AEBBOX	Stainless Steel Surface Surround for AEB2/AEB6

DOOR RELEASE CALL POINTS

M	M3A-G000SGSTCK12	Green Surface Emergency Door Release Call Point
	AEB37	Stainless Steel Touch Free Exit Button



All product specifications are supplied by the manufacturer. All manufacturers reserve the right to change specification without notification.

NOW STOCKING ESP PRODUCTS

Security Products

beacon Essentials

DOCBOX



UDATKIT



CCTV Kits

rekor HD

RHD8KD4G



RHD4KB4G



RHD4KD2W



RHD4KB2W



Smart Security Products

fort

ECSPK3B



ECSPSP



Access Control

aperta

EZT3K



INTRINSICALLY SAFE FLAME DETECTOR

INTRINSICALLY SAFE FLAME DETECTOR

A	16571	Intrinsically Safe Dual IR Flame Detector, Die-cast Zinc Alloy
	16579	Intrinsically Safe Triple IR Flame Detector, Die-cast Zinc Alloy
B	7127	Swivel Bracket
	IFD-E(EXD)	Infra Red Flame Detector Alloy Flameproof Housing
	IFD-E(IS)	Infra Red Intrinsically Safe Flame Detector Alloy Housing

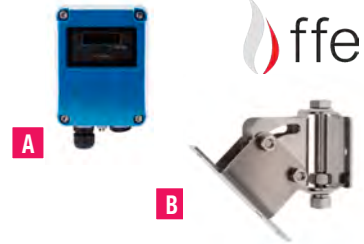

INTRINSICALLY SAFE CALL POINTS

INTRINSICALLY SAFE CALL POINTS

	M1A-R470SGK01381	Intrinsically Safe Red Indoor Call Point, 470 Ohm, Surface
C	W1A-R470SGK01381	Intrinsically Safe Red Call Point, 470 Ohm IP67
	WCP3A-R000SG01IS	Intrinsically Safe Red Call Point (No Resistor) IP67

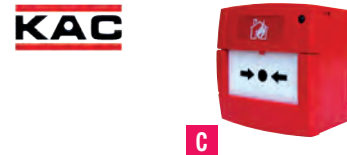

INTRINSICALLY SAFE SOUNDERS

INTRINSICALLY SAFE SOUNDERS

	IS-MA1-R	Intrinsically Safe Red Sounder IP65, 24V, 25mA
	IS-MB1-R/R	Intrinsically Safe Red LED Beacon IP65, 24V, 25mA
D	IS-MC1-R/R	Intrinsically Safe Red Sounder LED Beacon IP65 24V, 48mA



ISOLATING BARRIERS

ISOLATING BARRIERS

	DX070	Two Way Barrier Cabinet
	MTL5522	Alarm Driver Maximum 80mA Load (For use with IS Sounders/Beacons)
E	MTL5561	Dual Isolating Barrier (For use with IS Smokes & Heats)



EXPLOSION PROTECTED ATEX APPROVED CALL POINTS

EXPLOSION PROTECTED ATEX APPROVED CALL POINTS

F	BEXCP3A-BG	Exed Explosion Protected Red Call Point (No Resistor)
	BEXCP3B-BG	Exed Explosion Protected Red Call Point 470 Ohm



INTRINSICALLY SAFE FIRE DETECTION DEVICES

APOLLO ORBIS INTRINSICALLY SAFE DETECTORS

	ORB-OP-52027-APO	Orbis Intrinsically Safe Optical Smoke Detector
	ORB-OH-53027-APO	Orbis Intrinsically Safe Multisensor Detector
	ORB-HT-51157-APO	Orbis Intrinsically Safe A1S Heat Detector
	ORB-HT-51147-APO	Orbis Intrinsically Safe A2S Heat Detector
	ORB-HT-51151-APO	Orbis Intrinsically Safe BS Heat Detector
	ORB-HT-51155-APO	Orbis Intrinsically Safe CS Heat Detector
	ORB-HT-51145-APO	Orbis Intrinsically Safe A1R Heat Detector
	ORB-HT-51149-APO	Orbis Intrinsically Safe BR Heat Detector
	ORB-HT-51153-APO	Orbis Intrinsically Safe CR Heat Detector
	ORB-MB-50018-APO	Orbis Intrinsically Safe Timesaver Base
	ORB-BA-50008-APO	Orbis Intrinsically Safe Base Adaptor

orbis **apollo**



All product specifications are supplied by the manufacturer. All manufacturers reserve the right to change specification without notification.

SOLO AEROSOL SMOKE TEST



A5 FOR USE WITH SOLO SMOKE DISPENSER

A SOLO-A5-001 Smoke Detector Tester 250ml

C3 FOR USE WITH SOLO SMOKE DISPENSER

B SOLO-C3-001 Carbon Monoxide Fire Detector Tester

SMOKE SABRE HAND HELD SMOKE DETECTOR TESTER

C SOLO-SABRE Smoke Detector Test with Telescopic Funnel

A10 FOR USE WITH SOLO SMOKE DISPENSER, BOXED IN 12'S

SOLO-A10-001 Smoke Detector Test Gas 150ml (Non-Flammable)

SOLO-A10S-001 Smoke Detector Test Gas 250ml (Non-Flammable)

SOLO PARTS



SOLO101-001 Fibreglass Extension Pole 1.13 Metre

SOLO108-001 Fibreglass 2 Section Telescopic Pole (Extends to 2.5 Metre)

SOLO100-001 Fibreglass 4 Section Telescopic Pole (Extends to 4.5 Metre)

D SOLO330-001 Aerosol Smoke Dispenser Cup

E SOLO200-001 Universal Detector Removal Tool

F SOLO461-001 Cordless Heat Detector Tester c/w 2 Batteries

SOLO424-001 240V Heat Detector Tester with 5 Metre Cable

SOLO610-001 Storage Bags for Solo Poles & Tools

SOLO KITS



G SOLO365-001

Solo 365 Smoke Detector Tester Kit

Includes:-
1 x SOLO365-001 Head Unit
1 x SOLO370-001 Lithium Ion Battery Pack
1 x SOLO371-001 Smoke Generator

1 x SOLO-ES3-1 Smoke Cartridge
1 x SOLOSPARE-1060 Charger & USB Lead

SOLO811 Smoke Detector Tester & Head Removal Kit

Includes:-
1 x SOLO100-001 Fibreglass Telescopic Pole 4.5 Metre
1 x SOLO330-001 Aerosol Smoke Dispenser

1 x SOLO200-001 Universal Detector Removal Tool
1 x SOLO610-001 SOLO Kit Storage Bags
1 x SOLO-A10-001 Test Gas

SOLO814-001 Smoke & 240V Heat Detector Tester & Head Removal Kit

Includes:-
1 x SOLO100-001 Fibreglass Telescopic Pole 4.5 Metre
1 x SOLO330-001 Aerosol Smoke Dispenser
1 x SOLO424-001 240V Heat Detector Tester

1 x SOLO200-001 Universal Detector Removal Tool
1 x SOLO610-001 SOLO Kit Storage Bags
1 x SOLO-A10-001 Test Gas

H SOLO822-001

Smoke & Cordless Heat Detector Tester & Head Removal Kit

Includes:-
1 x SOLO100-001 Fibreglass Telescopic Pole 4.5 Metre
1 x SOLO330-001 Aerosol Smoke Dispenser
1 x SOLO461-001 Cordless Heat Detector Tester

1 x SOLO200-001 Universal Detector Removal Tool
1 x SOLO610-001 SOLO Kit Storage Bags
1 x SOLO-A10-001 Test Gas
2 x Batteries

SOLO823-001

Smoke & Cordless Heat Detector Tester & Head Removal Kit

Includes:-
3 x SOLO101-001 Fibreglass Extension Pole 1.13 Metre
1 x SOLO100-001 Fibreglass Telescopic Pole 4.5 Metre
1 x SOLO330-001 Aerosol Smoke Dispenser
1 x SOLO461-001 Cordless Heat Detector Tester

1 x SOLO200-001 Universal Detector Removal Tool
1 x SOLO610-001 SOLO Kit Storage Bags
1 x SOLO-A10-001 Test Gas
2 x Batteries

All product specifications are supplied by the manufacturer. All manufacturers reserve the right to change specification without notification.

Two versions of Testifire are available. The TF1001 incorporates heat & smoke testing capability & the TF2001 has in addition a CO fire detector test mode.

- Smoke and heat testing in one single tool.
- Consecutive or simultaneous testing of multi criteria detectors.
- Fast and economical testing.
- Developed with leading detector manufacturers to ensure universal compatibility.
- Compatible with other SOLO equipment & poles.



URBAN KITS

URBAN KITS

- URBAN365-001 Urban Smoke Test Kit
- URBAN1001-1-001 Urban Smoke / Heat Test Kit
- URBAN2001-1-001 Urban Smoke / Heat / CO Test Kit



Urban 365 Smoke Test Kit

Includes:-

- 1 x Urban Backpack (inc. Pole Bag)
- 1 x Urban 4-section Telescopic Pole 1.75m
- 3 x Urban Extension Pole 0.5m
- 1 x Solo 365 Smoke Kit

Urban Smoke / Heat Test Kit

Includes:-

- 1 x Urban Backpack (inc. Pole Bag)
- 1 x Urban 4-section Telescopic Pole 1.75m
- 3 x Urban Extension Pole 0.5m
- 1 x Testifire 1001-1 Smoke/Heat Kit

Urban Smoke / Heat / CO Test Kit

Includes:-

- 1 x Urban Backpack (inc. Pole Bag)
- 1 x Urban 4-section Telescopic Pole 1.75m
- 3 x Urban Extension Pole 0.5m
- 1 x Testifire 2001-1 Smoke/Heat/CO Kit

TESTIFIRE KITS

TESTIFIRE SMOKE CARTRIDGE FOR USE WITH TESTIFIRE TOOLS

- TF3-1PACK Testifire TS3 Smoke Capsule (Per 1)
- TF3-6PACK Testifire TS3 Smoke Capsule (Per 6)

TESTIFIRE CO CARTRIDGE FOR USE WITH TESTIFIRE TOOLS

- TF3C-1PACK Testifire TC3 CO Capsule (Per 1)
- TF3C-6PACK Testifire TC3 CO Capsule (Per 6)

TESTIFIRE KITS

- TF1001-001 Testifire Smoke/Heat Detector Tester
- TF2001-001 Testifire Smoke/Heat and CO Detector Tester
- TF6001-001 Testifire Smoke/Heat Kit c/w 2 Batteries, 4.2m Pole
- TF9001-001 Testifire Smoke/Heat Kit c/w 2 Batteries, 9m Pole

TF6001-001 Testifire Kit

Includes:-

- 1 x Testifire 1000-001 Smoke/Heat Test Head
- 1 x TS3 Smoke Capsule
- 2 x SOLO770-001 Battery Sticks
- 1 x SOLO727-001 Multi Voltage Fast Charger
- 1 x SOLO100-001 4.5m Fibreglass Access Pole
- 1 x SOLO200-001 Universal Detector Removal Tool
- 1 x SOLO610-001 Storage Bag

TF9001-001 Testifire Kit

Includes:-

- 1 x TF1000-001 Smoke/Heat Test Head
- 1 x TS3 Smoke Capsule
- 2 x SOLO770-001 Battery Sticks
- 1 x SOLO727-001 Multi Voltage Fast Charger
- 1 x SOLO100-001 4.5m Fibreglass Access Pole
- 3 x SOLO101-001 1.13m Fibreglass Extension Pole
- 1 x SOLO200-001 Universal Detector Removal Tool
- 1 x SOLO610-001 Storage Bag



ASPIRATING TEST KITS

SCORPION

- SCORP1001-001 Scorpion Point Head Installation Kit
- SCORP2001-001 Scorpion ASD Head Installation Kit
- SCORP8000-001 Scorpion Control Panel
- SCORP7000-001 Scorpion Engineers Portable Controller
- SCORP60-001 Scorpion Battery Baton Cable



For use with aspirating systems. Fixed solution for inaccessible areas, e.g. lift shafts, stairwells, data centres and escalators.

All product specifications are supplied by the manufacturer. All manufacturers reserve the right to change specification without notification.

TEST METERS

	KEW337	Light Meter, range 40,000 Lux
A	KT1790	Voltage Detector/Continuity Tester, LED & LCD Display with built in touch
	KEWSTICK-DUO	Voltage Detection Stick
B	ACT612	6V-12V Battery Tester
	ACT1345	Sound Level Meter 30-130dB



LADDERS

WERNER

	W-71604	Fibreglass Swingback Stepladder 4 Tread 1.12m
	W-71605	Fibreglass Swingback Stepladder 5 Tread 1.40m
C	W-71606	Fibreglass Swingback Stepladder 6 Tread 1.67m
D	W-78069	Aluminium Work Platform
	W-79009	Ladder Roof Rack Clamp



MODULEX

THE "ONE FOR ALL" FIRE EXTINGUISHER STAND

Key Features

- Modular design allows for multiple configurations
- Tough and durable polypropylene construction
- Safe for food preparation areas
- Excellent anti-static properties
- Landscape and portrait signs
- Bespoke colours available
- Company branding available
- 100% Recyclable
- Super compact patent pending "Flat Pack Design"

Specifications

Dimensions (WxDxH)	295 x 270 x 665
Colours	Grey, Magnolia, Red
Weight	1.4Kg



Made in the UK.



All product specifications are supplied by the manufacturer. All manufacturers reserve the right to change specification without notification.

EXTINGUISHERS, SPARES & BLANKETS

WATER FIRE EXTINGUISHERS

A	6LTR	6Ltr Stored Pressure Water Fire Extinguisher
	9LTR	9Ltr Stored Pressure Water Fire Extinguisher

AFFF FOAM FIRE EXTINGUISHERS

B	2LTR	2Ltr Stored Pressure AFFF Foam Fire Extinguisher
	6LTR	6Ltr Stored Pressure AFFF Foam Fire Extinguisher
	9LTR	9Ltr Stored Pressure AFFF Foam Fire Extinguisher

CO2 EXTINGUISHERS

	2KG	2KG CO2 Extinguisher
	5KG	5KG CO2 Extinguisher

DRY POWDER FIRE EXTINGUISHERS

	1KG	1Kg Dry Powder Fire Extinguisher
	2KG	2Kg Dry Powder Fire Extinguisher
C	4KG	4Kg Dry Powder Fire Extinguisher
	6KG	6Kg Dry Powder Fire Extinguisher
	9KG	9Kg Dry Powder Fire Extinguisher

EXTINGUISHER STANDS/CABINETS

	FMCMODSR	Modulex Stand Red
	FMCMODSG	Modulex Stand Grey
	FMCCAB1	FMC Single Cabinet
	FMCCAB2	FMC Double Cabinet
	EXTCOVER3	Extinguisher Jacket to suit 2kg Co2 - 6L-9L

FIRE BLANKET

D		1.2m x 1.2m Fire Blanket
----------	--	--------------------------

ENGINEERS SPARES

	P/SEAL	500 x Tamper Seals (Various Colours)
	HORNORING	100 x Horn O Ring
	HOSEORING	100 x Hose O Ring
	GAUGETESTER	Pump Gauge Tester
	SERVLAB	500 x Service Labels (Various Sizes)

EXTINGUISHER ANTI-THEFT DEVICE

E	STI-6200	Theft Stopper
	STI -6255	Mini Theft Stopper



FOR EXTINGUISHER SIGNS SEE PAGE 65

CAN'T FIND WHAT YOU'RE LOOKING FOR?
WE'RE HAPPY TO HELP!

Call us today on 01425 658239 or email sales@detectionsupplies.co.uk

All product specifications are supplied by the manufacturer. All manufacturers reserve the right to change specification without notification.

STI PROTECTIVE STEEL CAGES & COVERS

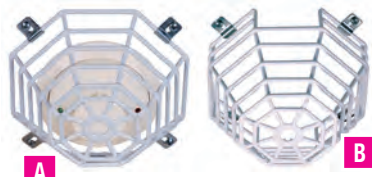

A

B

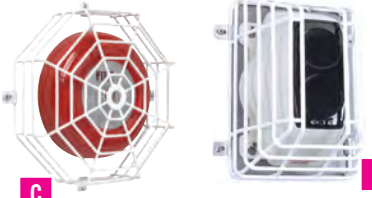

C

D



E

F

ALSO AVAILABLE IN GREEN

SMOKE DETECTOR & SOUNDER CAGES

- A STI-9604 Steel Cage Protector 175 Dia. x D75mm
- B STI-9605 Steel Cage Protector 180 Dia. x D115mm
- STI-9606 Steel Cage Protector 175 Dia. x D95mm
- STI-9610 Steel Cage Protector 210 Dia. x D152mm

EMERGENCY LIGHTING CAGES

- STI-9644 Steel Cage Protector H220 x W450 x D128mm

BELL & CLOCK CAGES

- C STI-9631 Steel Cage Protector 270 Dia. x D152mm

MOTION DETECTOR CAGES

- D STI-9624 Motion Detector Steel Cage Protector, H225 x W140 x D120mm

BEACON/SOUNDER CAGES

- E STI-9617 Beacon & Sounder Steel Cage Protector, 149 Dia. x D127mm
- STI-9665 Steel Cage Protector 134 Dia. x D214mm

EXIT STOPPER

- F STI-6400 Exit Stopper, Red with PP3 Battery

STI STOPPER CALL POINT COVERS

OTHER COLOURS AVAILABLE



G

H

STANDARD STOPPER COVERS

- G STI-1230 Stopper II, Surface, Large Polycarbonate Cover
- H STI-6931 Call Point Stopper, Surface, Red
- STI-13110FR Universal Stopper, Surface Dome Polycarbonate Cover, Red Fire
- STI-15C10ML Euro Stopper Cover Kit, Surface, Red & Green
- STI-3150 Weatherproof Stopper II, Surface

STANDARD STOPPER COVERS WITH TAMPER ALARM

- STI-15020ML Euro Stopper Cover Kit, Flush, Red & Green with Sounder
- STI-15C20ML Euro Stopper Cover Kit, Surface, Red & Green with Sounder
- STI-1130 Stopper II, Surface, Large Polycarbonate Cover with Sounder
- STI-13120EG Universal Stopper, Surface Dome Polycarbonate Cover with Sounder, Green Emergency Exit
- STI-13120FR Universal Stopper, Surface Dome Polycarbonate Cover with Sounder, Red Fire

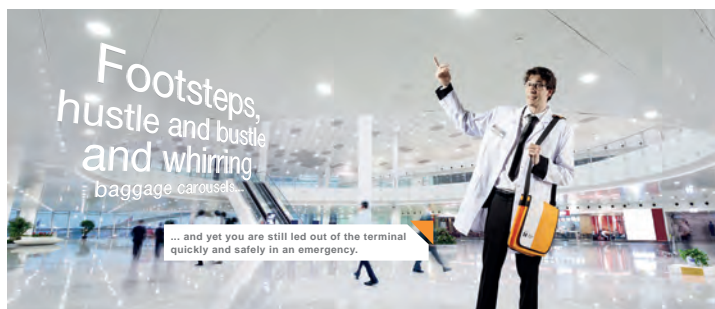

VX-3000

Voice Alarm System

Today, the issue of safety is more important than ever. At TOA, we have developed a reliable and energy-efficient voice alarm system that combines all functions in a single device. Whether in airports, hotels, offices, hospitals or schools, the flexible system architecture makes it scalable and expandable for all size requirements.

Full TOA range now available from Detection Supplies!

We supply sound, not equipment.
www.toa.co.uk

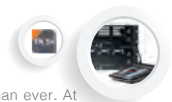

All product specifications are supplied by the manufacturer. All manufacturers reserve the right to change specification without notification.

KIDDE FYRNETICS FIRE & CO DETECTORS

MAINS RESIDENTIAL FIRE DETECTORS

- KF20 Optical Smoke Detector 230V with Battery, Linkable
- KF30 Heat Detector 57c 230V with Battery, Linkable

MAINS RESIDENTIAL FIRE DETECTORS, 10 YEAR BATTERY BACKUP

- KF20R Optical Smoke Detector 230V with Battery, Linkable, 10 Year Battery Life
- KF30R Heat Detector 57c 230V with Battery, Linkable, 10 Year Battery Life

BASE OPTIONS

- A SMK4896 Option pattress base for KF/KFR
- PATCO Optional Pattress for 4MCO/ 4MCO
- SMK23RU 8 Amp Relay Base 240V Rated

TEST/HUSH SWITCHES

- B REMTH Remote Test & Hush Switch (Wired)

MAINS CARBON MONOXIDE DETECTOR 10 YEAR BATTERY BACKUP

- C 4MCO CO Detector 230V Linkable with 10 Year Lithium Battery
- 4MDCO CO Detector 230V with Digital Display & Recall

CARBON MONOXIDE DETECTOR 10 YEAR BATTERY

- D 10LLCOB CO Detector with 10 Year Life Battery
- 10LLDCOB CO Detector with Digital Memory and 10 Year Life Battery

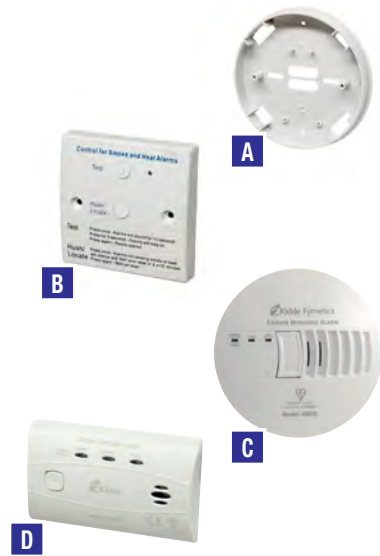

AICO RESIDENTIAL DETECTORS

MAINS POWERED SMOKE & HEAT ALARMS & BASES

- E EI3016 Mains Powered Optical Smoke Detector + 10 Year Life Battery
- EI3014 Mains Powered Heat Detector + 10 Year Life Battery
- EI3018 Mains Powered CO Detector + 10 Year Life Battery
- EI3000MRF Smartlink Module



BATTERY POWERED SMOKE & HEAT ALARMS

- EI650I Battery Powered Optical Smoke Detector
- F EI630I Battery Powered Heat Detector
- EI6501RF RadiolINK+ Optical Smoke Detector
- EI6301RF RadiolINK+ Heat Detector

CARBON MONOXIDE ALARMS

- G EI208 Battery Powered Carbon Monoxide Alarm
- EI208WRF RadiolINK+ Battery Carbon Monoxide Alarm

ALARM ACCESSORIES & INTEGRATION

- EI450 Alarm Controller
- EI407 RadiolINK Remote Manual Call Point



C-TEC HUSH - ACTIV

MAINS POWERED SMOKE & HEAT ALARMS & BASES

- H HAK/1 1x Hush Controller, 1 x PSU, 3 X ActiV Bases, 1 x ActiV Multi Sensor, 1 x ActiV Smoke Detector, 1 X ActiV Heat Detector and 1 x ActiV Base Sounder c/c Lid & Adapter Plate.
- I BF-DP Retrofit Decor Plate (to cover decorating marks on retro installs)



All product specifications are supplied by the manufacturer. All manufacturers reserve the right to change specification without notification.

C-TEC EMERGENCY VOICE COMMUNICATION SYSTEM



Suitable for use as:

- Disabled Persons Refuge Alarm
- Fire Telephone System
- Stadium Marshal Applications

The Master Control Panel can be used with both Type A Fire Telephone Outstations or if required for use as a Disabled Refuge Alarm, Type B Stainless Steel Hands Free Speech Outstations.

DISABLED REFUGE 4-8 LINE CONTROLLERS

ECU-4	Emergency Refuge Alarm 4 Way Master Controller (Requires 2x7Ah Batteries)
ECU-8	Emergency Refuge Alarm 8 Way Master Controller (Requires 2x7Ah Batteries)
ECU-16	Emergency Refuge Alarm 16 Way Master Controller (Requires 2x7Ah Batteries)
ECU722	Network Communication Card for ECU4,8 & 16
ECU723	Interface/Network Communication Card for ECU4, 8 & 16

DISABLED REFUGE OUTSTATIONS (TYPE B)

EVC302GF	Refuge Alarm Outstation, Green Flush Mount (Type B)
EVC302GS	Refuge Alarm Outstation, Green Surface Mount (Type B)
EVC302F	Refuge Alarm Outstation, Flush Stainless (Type B)
EVC302S	Refuge Alarm Outstation, Surface Stainless (Type B)

FIRE TELEPHONE OUTSTATIONS (TYPE A)

EVC301RPO	Fire Telephone in Red Metal Box, Push To Open Door (Type A)
EVC301RLK	Fire Telephone in Red Metal Box, Lift Lock Version (Type A)

C-TEC INDUCTION LOOP EQUIPMENT



Induction Loop Systems allow hearing aid users to participate in general conversation in domestic, retail & working environments. Modular systems also available to suit most applications, please phone for details.

PORTABLE INDUCTION LOOP KIT

PDA-PL1-K1	Portable Induction Loop Kit in Cardboard Carry Case
PDA-PL1-K3	Portable Induction Loop Kit in Plastic Carry Case

COUNTER INDUCTION LOOP KIT

PDA-ML1-K	Counter Induction Loop Kit with AMT Microphone
-----------	--

ROOM INDUCTION LOOP KIT

PDA-103L	Small Room Induction Loop Kit 50m ² (Tie/Desk Mic)
PDA-103R	Small Room Induction Loop Kit 50m ² (Omni Mic)
PDA-103S	TV Lounge Induction Loop Kit 50m ² with Connection Plate
PDA-AKL1	Lecture Room Induction Loop Kit 120m ²
PDA-AKM1	Meeting Room Kit with Omni directional Mic 120m ²
PDA-AKT1	TV/Music Lounge Induction Loop Kit 120m ² with APJ-APL Plates & Mic

CABLE

PDA-FLAT2005	Insulated Copper Tape 100m x 1.0mm
PDA-FLAT3005	Insulated Copper Tape 100m x 1.5mm
PDA-LOOP2/W	100m x 1.0mm ² White Loop Cable
PDA-LOOP3/W	100m x 1.5mm ² White Loop Cable

ACCESSORIES

PDA-FPROK1	Fosmeter Induction Loop Test Kit
PDA-TEAR10	Induction Loop Fitted Sticker (Pack of 10)

C-TEC ACCESSIBLE TOILET ALARMS



C-TEC NC951 ACCESSIBLE TOILET ALARM KIT

New call accept function
BS8300 and Equality Act compliant
Attractively designed
On-board battery backup

SINGLE WAY ACCESSIBLE TOILET ALARM

NC951	Accessible Toilet Alarm Kit with Call Accept Function and Battery Backup
-------	--

MULTI WAY SYSTEM

NC944	4 Zone Controller (Requires NC930 PSU)
NC930	Power Supply 12V 250mA On 2 Gang Plate
NC807C	Ceiling Pull Cord
NC806CS	Over Door Light with Sounder

All product specifications are supplied by the manufacturer. All manufacturers reserve the right to change specification without notification.

VOX IGNIS EMERGENCY VOICE COMMUNICATIONS SYSTEMS

MASTER STATIONS

ViLX-228N-0	Lexicomm Master Station Non-line Master Repeater
ViLX-228N-2	Lexicomm 2 Line Master Station
ViLX-228S-2	Solo 2 Line Stand Alone Master Station
ViLX-228S-2-SS	Solo 2 Line Stand Alone Master Station SS
ViLX-228N-4	Lexicomm 4 Line Master Station
ViLX-228S-4	Solo 4 Line Stand Alone Master Station
ViLX-228S-4-SS	Solo 4 Line Stand Alone Master Station SS
A ViLX-228N-8	Lexicomm 8 Line Master Station
ViLX-228S-8	Solo 8 Line Stand Alone Master Station
ViLX-228S-8-SS	Solo 8 Line Stand Alone Master Station SS
ViLX-TMS3-W-0	Lexicomm Network Touchscreen Master Station Zero-line Master Repeater
B ViLX-TMS3-W-8	Lexicomm Network Touchscreen Master Station complete with 8 Integral Lines
ViLX-TMS3-W-0-SS	Lexicomm Network Touchscreen Repeater Station
ViLX-TMS3-W-8-SS	Lexicomm Network Touchscreen Master Station
ViLX-ACM3-8	Lexicomm Network Assist Call Touchscreen Master Station
ViLX-ACR	Lexicomm Network Touchscreen Repeater Station
ViLX-EX8	Lexicomm Network 8 Line System Expander Panel
ViLX-EX8-AB	Adaptor Board to Connect the ViLX-ACR to the ViLX-EX8
ViLX-TMS3-AB	Adaptor Board to Connect the ViLX-ACR to the ViLX-TMS3
ViLX-LC2	Lexicomm 2 Way Line Card PCB to allow the expansion of the ViLX-228 and ViLX-TMS Controllers
ViLX-CBZ	Semi-Recess Flush Mount Stainless Steel Bezel for the ViLX-228 & ViLX-NET Controllers
ViLX-RAP	Remote Alarm Panel, Provides audible and visual indication of either a Refuge or Assist Call Activation.

OUTSTATIONS

C ViLX-OSA	Lexicomm Surface Type A Fire Telephone Handset in a Stainless Steel Box with Red Screen Print
ViLX-OSA-R	Lexicomm Surface Type A Fire Telephone Handset. Finished in Signal Red, RAL 3001 c/w White Signage
D ViLX-OSB-G	Lexicomm Type B Refuge Point on a Double Gang Stainless Steel Plate (Back Box Not Supplied)
ViLX-OSB-SS	Lexicomm Type B Refuge Point on a Double Gang c/w Stainless Steel Facia with Green Edge. (Back Box Not Included)
ViLX-ILB-F	Lexicomm type B Refuge Point, with Integral Induction Loop supplied as a Flush Stainless Steel Plate
E ViLX-OSC	Lexicomm Combined Type A Telephone and Type B Refuge Point in a Surface Stainless Steel Box
ViLX-IPA2	Lexicomm IP66 Weatherproof Type A Fire Telephone, Supplied in a Sheet Steel Enclosure Colour Grey RAL 7035 with Red High Contrast Signage with Hinged Door and Thumbturn Lock for Access.
ViLX-IPB2	Lexicomm IP65 Weather Proof Type B Refuge Point, Supplied in a Sheet Steel Enclosure Colour Grey RAL 7035 with Hinged Door and Thumbturn Lock for Access.
ViLX-OBZ	Flush Mounting Stainless Steel Bezel for the ViLX-OSA & ViLX-OSC
ViLX-OBZ-R	Flush Mounting Signal Red Steel Bezel for ViLX-OSA-R

INTEGRATED EMERGENCY ASSIST CALL 2 WIRE CALL SYSTEM

ViLX-ACA	Lexicomm Assist Call Alarm WC System, Comprises of Over-door Plate, Cancel Plate and Pull Cord Brushed Stainless Steel Finish with Acknowledge Function
ViLX-ODP	Assist Call Over-door Plate, Brushed Stainless Steel Finish, Single Gang Plate with Blue Halo Indication and Buzzer
ViLX-CNP	Assist Call Cancel Plate, Brushed Stainless Steel finish, Single Gang Plate with Blue Halo Indication and Buzzer
ViLX-CPP	Assist Call pull cord, brushed stainless steel finish, single gang plate with blue indication and 3m cord with two 50mm diameter red rings

VOX IGNIS ASSIST CALL STANDALONE KITS

VIAC-STK	Assist Call Standard Kit, Comprises of 1 x VIAC-PSC (PSU/over-door), 1 x VIAC-CNP (cancel plate), 1 x VIAC-CPP (pull cord) and 1 x VIAC-WCS (WC sticker). Brushed Stainless Steel Plates with Blue Halo Indication.
VIAC-RTK	Assist Call Remote Kit, Comprises of 1 x VIAC-1ZC (1 zone controller PSU with accept), 1 x VIAC-ODP (overdoor plate), 1 x VIAC-CNP (cancel plate), 1 x VIAC-CPP (pull cord) and 1 x VIAC-WCS (WC sticker). Brushed Stainless Steel Plates with Blue Halo Fully compliant with BS8300 for Remote Toilets, Controller placed in the staffed area provides the acknowledge function.
VIAC-4ZC	Assist Call 4 Zone Controller, Brushed Stainless Steel Finish, Double Gang Plate with Blue Halo Indication, 4 Zone Indicators, Buzzer, Buzzer Volume Control, Active Relay and Accept Button. Fully Compliant with BS8300 for Remote Toilets, Controller placed in the staffed area provides the acknowledge function.

All Lexicomm Emergency Voice Communications Systems (EVCS) are designed to comply fully with the requirements of BS5839-9:2011 for use as a fire telephone system (FT), disabled refuge system (DRS) or as a combined system when both fire telephones and disabled refuge call points are required. Master Stations require 1 x 7Ah Batteries

Key Features:

- Compact Design
- Fully Compliant to BS5839-9: 2011
- Integrated Assist Call and Acknowledge meeting BS8300
- 1.5A EN54-4:A2 PSU
- Full Duplex operation
- Wall mount enclosure
- Lockable handset cover
- Expandable from 2 to 8 lines
- Touchscreen network system up to 512 lines
- Inbuilt networking

Vox Ignis
The Voice of Fire



A



C



D



B



E



FIRE CABLE & ACCESSORIES

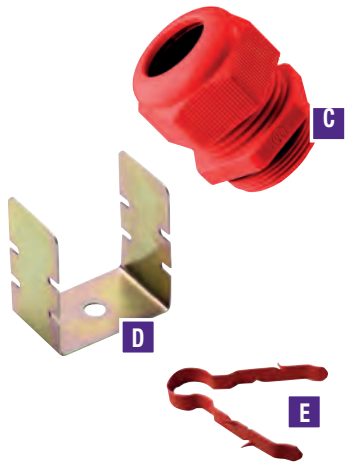
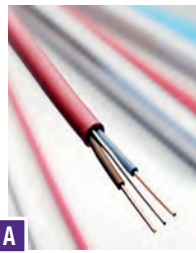

GOLD

A P-2C1RED	FP200GOLD 100 Metres 2 Core 1 Red
VFP-215ERD	NOBURN 100 Metres 2 Core 1.5 Red
P-2C2.5RED	FP200GOLD 100 Metres 2 Core 2.5 Red
P-2C4RED	FP200GOLD 100 Metres 2 Core 4 Red
VFP-415ERD	NOBURN 100 Metres 4 Core 1.5 Red

PLUS ENHANCED

VNP-215ERD	NOBURN PLUS Enhanced 2 Core 1.5, Red 100M
P-2C2.5RED-ENHANCED	FP200 PLUS Enhanced 2 Core 2.5, Red 100M
P-2C4RED-ENHANCED	FP200 PLUS Enhanced 2 Core 4, Red 100M
VNP-415ERD	NOBURN PLUS Enhanced 4 Core 1.5, Red 100M

CLIPS AND GLANDS (ALSO AVAILABLE IN BLACK & GREY)

B P-AP7	FP200 Red "P" Clip for 2c 1.5 Cable (Per 100)
P-AP9	FP200 Red "P" Clip for 4C 1.5 cable (Per 100)

NYLON CABLE GLANDS

C EPN250-M20R	Protec Quick-Fit Nylon Cable Glands with Locknut, Red (pack 10)
EPN250-M20W	Protec Quick-Fit Nylon Cable Glands with Locknut, White (pack 10)

STAINLESS STEEL CABLE TIES (PACK OF 100)

FRCT150	Stainless Steel Cable Ties 150 x 4.5mm
FRCT200	Stainless Steel Cable Ties 200 x 4.5mm
FRCT300	Stainless Steel Cable Ties 300 x 4.5mm

FIRE RATED CLIPS

D D30	Safe D. 23mm Fire Rated Cable Clips (Pack of 50)
D40	Safe D. 31mm Fire Rated Cable Clips (Pack of 50)
D50	Safe D. 46mm Fire Rated Cable Clips (Pack of 50)
E 1LCR608	Linian 6-8mm Clips, Red Single (Per 100)
1LCR68/2	Linian 6-8mm Clips, Red Double (Per 100)



1 Drill 5.5mm diameter hole into the required material.

2 Slide the LINIAN Clip over the cable, so that it is seated in the rounded area.

3 Compress the LINIAN Clips legs and simply insert into the hole by hand.

(Installation in just 3 simple steps)

FIREFLY FIRE SAFETY CLIPS

Firefly clips meet the requirements of the BS7671:2018 wiring Regulations to secure all surface cables with metal clips, Preventing fire-fighting and people escaping burning buildings from becoming entangled.

The 18th Edition regulations which came into effect from January 2019 prohibit non-metallic clips or plastic trunking as the sole means of support.

Firefly clips have been specially developed with a new, flexible design to make them suitable for all popular sizes of plastic trunking. Firefly clips feature rounded ends, preventing damage to cables and injury to electricians

Whats more, their spring-loaded design makes it straightforward to add or remove cables in the months and years after installation. The full ranger included a variety of clips to secure cables both inside and outside trunking and conduits.



EXTERNAL FLAT CLIPS (PACK OF 50)

F FFC1EXTR	Red Flat Clips for 16 x 16 Plastic Trunking
FFC2EXTR	Red Flat Clips for 25 x 16 Plastic Trunking
FFC4EXTR	Red Flat Clips for 40 x 25 Plastic Trunking

INTERNAL CLIP (PACK OF 100)

FFC1	Zinc Clips for 16 x 16 Plastic Trunking
FFC2	Zinc Clips for 25 x 16 Plastic Trunking
FFC4	Zinc Clips for 40 x 25 Plastic Trunking

MULTI HOLD CLIP (PACK OF 50)

G FFMHC75	Zinc Plated Multi-Hold, Multi Use Hanger, Frame Size 75 x 25mm
FFMHC100	Zinc Plated Multi-Hold, Multi Use Hanger, Frame Size 100 x 30mm

ACCESSORIES

FFC-MS4737M	100 Masonry Screws & Washers, 4.7mm x 37mm
FFC-CFSM	50 Metal Cavity Fixing & Screws

BUCKLE CLIP

H FFBC1	Buckle Clip
----------------	-------------

All product specifications are supplied by the manufacturer. All manufacturers reserve the right to change specification without notification.

DOCUMENT BOXES & LOG BOOK



DOCUMENT BOXES

	BF357	Lockable Metal Document/Key Box with 2 Keys W245 x H310 x D56
	A4-DOCBOX	A4 White Lockable Metal Document Box with 2 Keys W245 x H310 x D56
A	A4-DOCBOX-R-FIRE	A4 Red Fire Lockable Metal Document Box with 2 Keys
	K16000L2	Lockable Metal Document/Key Box with 2 Keys W385 x H310 x D60
	K16000M2	Lockable Deep Document Box with 2 Keys W385 x H310 x D90

FIRE LOG BOOK

B	FD-LB	Fire Detection & Fire System Log Book.
	FA-LB	Customised Log Book with own Company Logo and details.

ZONE PLANS



Zone plans are required for every fire alarm system, under the current recommendations. These show the division of the building into zones, using a different colour for each zone. A simple plan of the building, or full architectural plans can be used to provide a clear representation of the building.

These plans are printed onto 5mm acrylic, then mounted on the wall with silver anodised stand-offs. The acrylic can be clear, white or frosted, to suit the decoration and give a truly professional and contemporary finish to the fire alarm system.

These glow in the dark zone plans are printed on 1.5mm thick rigid plastic, offering fantastic durability. Perfect for care homes, hotels, schools and industrial sites too. Fire zones are printed in a diagonal hatch style, maximising the impact of the photo-luminescent plastic.

These plans are framed with a stylish silver anodised finish, with clear plastic flexible cover suitable for all types of premises. The plans are loaded into the front of the frame making it easy to change the plan should it become inaccurate after building changes.

Call us now for more details and prices.

FIRE RATED SEALANT & EXPANDING FOAM

FIRE RATED EXPANDING FOAM

C	FP-111	Fire Mate Sealant C3
D	FP-135	Pyro Mate Sealant C3
E	FP-999	Fire Rated Foam 750ml



Fire Mate Sealant
A single part, emulsion acrylic based, Intumescent Acoustic sealant that provides a firm, flexible seal to joints in a variety of fire rated structures. 5 hour rated.

C



Pyro Mate Sealant
A neutral cure, elastic silicone sealant which conforms to the DN4102 standard for fire retardancy and has a fire rating of up to 4 hours in certain joint configuration.

D



Fire Rated Expanding Foam
Fire rated polyurethane expanding foam, that is designed to prevent the spread of fire and smoke from one compartment to another through gaps, voids, fire rated walls or floors.

E

CAN'T FIND WHAT YOU'RE LOOKING FOR?
WE'RE HAPPY TO HELP!

Call us today on 01425 658239 or email sales@detectorsupplies.co.uk

All product specifications are supplied by the manufacturer. All manufacturers reserve the right to change specification without notification.

For more information or to place an order:

Phone: 01425 658239

Fax: 01425 658241

Email: sales@detectorsupplies.co.uk

VIMPEX HYDROSENSE WATER LEAK DETECTION

The Hydrosense Water Leakage Detection System is designed to protect areas where water ingress could seriously damage electrical, communication and computer networks. When installed in vulnerable areas it continuously monitors for water leaks.

Hydrosense can be installed in a wide range of applications including HVAC, sprinkler systems and water-cooled plant.

VIMPEX HYDROSENSE



HYDROSENSE CONTROL PANELS

HSCP-S-2	2 Zone Hydrosense CP Panel
HSCP-S-2-AP	2 Zone Hydrosense CP Panel with Ancillary PCB
HSCP-S-4	4 Zone Hydrosense CP Panel
HSCP-S-4-AP	4 Zone Hydrosense CP Panel with Ancillary PCB
HSCP-S-8	8 Zone Hydrosense CP Panel
HSCP-S-8-AP	8 Zone Hydrosense CP Panel with Ancillary PCB

HYDROSENSE SYSTEM COMPONENTS & ACCESSORIES

HS-WLDP	Leak Detection Probe
HS-WLJB	Leak Detection Probe Junction Box
HY-WLRI-F	Remote Lamp Unit
HY-WLRI-S	Remote Indicator "Water Alarm" with Surface Mount Box
HYDW-05	Hydrowire (Water Detection Cable) 5m Length
HYDW-10	Hydrowire (Water Detection Cable) 10m Length
HS-HWCI	Hydrowire Connection Interface
HS-HWCI-EOL	Hydrowire End of Line Device
HY-FXSA	Fixing Clips for Leader and Hydrowire Cable - Screw or Adhesive Fix (Pack 100)
HSVS	"Water Leakage Alarm Activated" - 'Hydro-Cryer' Voice Sounder

Features

- Linear detection with Hydrowire
- Point detection with Floor and Drip Tray Probes
- 2,4 or 8 zone panels
- Choice of panel design and mounting
- Fully monitored detection and alarm circuits
- Easily installed, serviced and maintained
- Dedicated Hydro-Cryer "Water Leakage" messages available
- Remote "Water Alarm" lamp units available
- Zone breaker cables available
- Auxiliary alarm contacts
- Monitored alarm outputs
- Battery backup

Addressable Version Available, please call for details

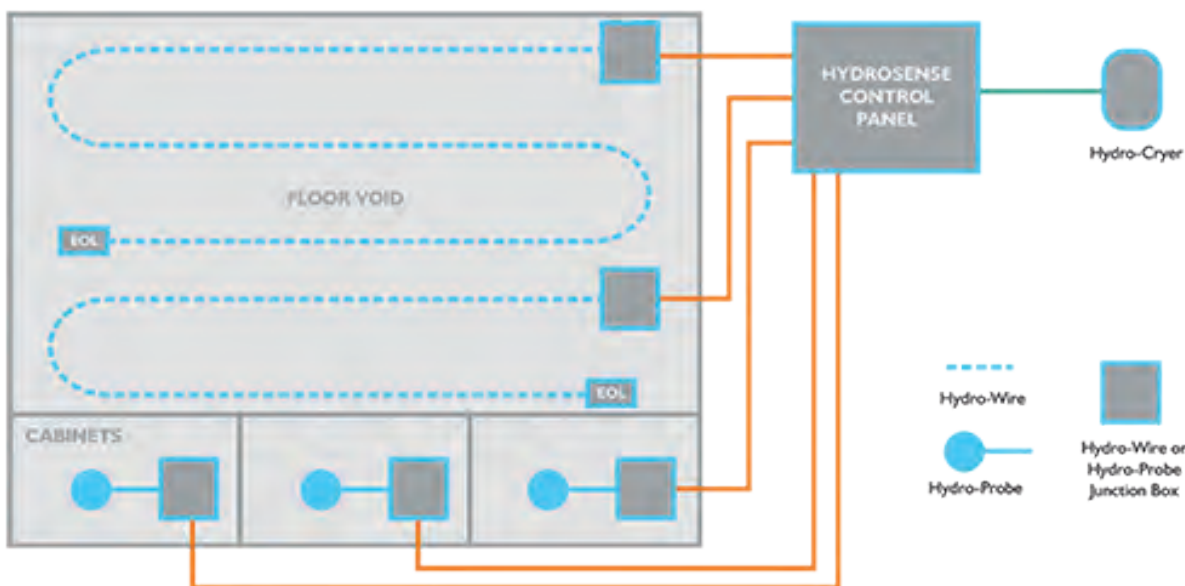

All product specifications are supplied by the manufacturer. All manufacturers reserve the right to change specification without notification.

AOV CONTROL UNITS

AOV PANELS

SZAOV-1001	SZAOV 3A Single Zone - Non Extendable
A MZAOV-1001A	MZAOV 3A Single Zone - Non Extendable
MZAOV-1001	MZAOV 3A 2 Zone - Extendable
MZAOV-1002	MZAOV 5A 2 Zone - Extendable
MZAOV-1003	MZAOV 10A 2 Zone - Extendable

PANEL ACCESSORIES

B MZAOV-3001	MZAOV 2 Zone Extension Card
MZAOV-3002	MZAOV Add on Card

24V CHAIN ACTUATORS

ACK424UNIW	ACK2 Chain Actuator 24V 100-400mm 300N 1.35A White
SMD800W	SuperMaster Chain Actuator 24V 800mm 350N White
SMD600W	SuperMaster Chain Actuator 24V 600mm 400N White
SMD450W	SuperMaster Chain Actuator 24V 450mm 400N White

CHAIN ACTUATOR BRACKETS

ACK4SB	Standard Bracket Set for ACK4 White
ACK4BBBKT	Z Bracket for a ACK4 Black
ACK4SPB	Small Pivot Brackets for a ACK4 White
ACK4LPB	Large Swivel Bracket for ACK4 White
SM40460	Slide Bracket for SuperMaster
SM40560	Pivot Bracket for Sintesi/SuperMaster/Microl/Microxl
SM40472W	Bottom Hung Bracket for SuperMaster

CALL POINTS

M3A-A000SG11	Orange Vent Release Surface Call Point (No Resistor)
BG2/FOS/O	Firemans Override Key-Switch Orange
BG1/FOS/O	Firemans Override Switch Orange
PS200	Hinged Call Point Cover

DETECTORS & ANCILLARIES

55000-317APO	Series 65 Optical Smoke Detector
445681-508APO	Series 65 12V Relay Base



A



B



All product specifications are supplied by the manufacturer. All manufacturers reserve the right to change specification without notification.

Z10 SAFETY EMERGENCY LED BULKHEADS



EMERGENCY LED BULKHEAD

BHD1.5-MT	IP65 LED Bulkhead 1.5W 170lm MT
BHD1.5-AST	IP65 LED Bulkhead 1.5W 170lm Self Test AST

MINI EMERGENCY LED BULKHEAD

BHB1.5 AST	IP65 LED Mini Bulkhead
------------	------------------------

ACCESSORIES

BHA-RK	Bulkhead Recess Kit
--------	---------------------

Z10 SAFETY EXIT SIGNS LED



EXIT SIGN BOX - LUMINAIRES

A	BXA34-SD	LED Exit Sign Box 1.5W 34m Viewing Distance Standard
	BXA34-AST	LED Exit Sign Box 1.5W 34m Viewing Distance Self Test AST

EXIT SIGN BOX - ACCESSORIES

BXA-D	Exit Sign Metal Box DOWN ARROW Legend
BXA-R	Exit Sign Metal Box RIGHT ARROW Legend
BXA-L	Exit Sign Metal Box LEFT ARROW Legend

EXIT SIGN BLADE - LUMINAIRES

B	EXA30-MT	LED Exit Sign 1.5W 30m Viewing Distance (Ceiling Mounted) MT
	EXA30-AST	LED Exit Sign 1.5W 30m Viewing Distance (Ceiling Mounted) Self Test AST

C	EXB24-MT	LED Exit Sign 1.5W 24m Viewing Distance (Suspension) MT
	EXB24-AST	LED Exit Sign 1.5W 24m Viewing Distance (Suspension) AST

EXIT SIGN BLADE - ACCESSORIES

EXA30-D	Exit Sign DOWN ARROW Legend
EXA30-RL	Exit Sign RIGHT-LEFT ARROW Legend
EXB24-D	Exit Sign DOWN ARROW Legend
EXB24-RL	Exit Sign RIGHT-LEFT ARROW Legend

EXA-RK	Exit Sign Recess Kit
--------	----------------------

EXB-SW	Suspension Kit 2m Length Wires
--------	--------------------------------

Z10 SAFETY EMERGENCY TWINSPOOT LED



TWINSPOT

TSA3-MT	IP65 LED Twinspot 2 X 1.5W 350lm MT
TSA3-AST	IP65 LED Twinspot 2 X 1.5W 350lm Self Test AST

Z10 SAFETY LED DOWNLIGHTS



LED DOWNLIGHTS RECESSED

DLC1.5-OA2-AST	Recessed LED Downlight NM 1.5W 150lm Open Area AST
DLC1.5-C-AST	Recessed LED Downlight NM 1.5W 140lm Corridor AST
DLA3-OA1-MT	Recessed LED Downlight NM 3W 270lm Open Area MT
DLA3-OA1-AST	Recessed LED Downlight NM 3W 270lm Open Area Self Test AST

LED DOWNLIGHTS CEILING MOUNTED

DLB1.5-OA2-MT	Ceiling Mounted LED Downlight NM 1.5W 150lm Open Area MT
DLB1.5-OA2-AST	Ceiling Mounted LED Downlight NM 1.5W 150lm Open Area Self Test AST
DLB1.5-C-MT	Ceiling Mounted LED Downlight NM 3W 270lm Corridor MT
DLB1.5-C-AST	Ceiling Mounted LED Downlight NM 3W 270lm Corridor Self Test AST
DLB3-OA1-MT	Ceiling Mounted LED Downlight NM 3W 270lm Open Area MT
DLB3-OA1-AST	Ceiling Mounted LED Downlight NM 3W 270lm Open Area Self Test AST

Z10 SAFETY REMOTE EMERGENCY PACK



RCK55-AST-3	Remote Emergency Pack 3 W 10-55V DC AST Pre-wired. C/W Twist & Lock Connectors
-------------	--

Z10 SAFETY EMERGENCY LIGHT TEST KEY SWITCH & REMOTE CONTROL



D	CMA110	Emergency Light Test Key Switch
	MI003	Test Key (Pack of 10)
E	ARC	Advance Remote Control

- * MT - This luminaire needs to be tested and test results recorded by a competent person according to BS EN 50172:2004.
- * AST - This is a self-test luminaire.

ESP EMERGENCY LED BULKHEADS

EMERGENCY LED BULKHEAD

A	EM14WMCBULK	LED 14W Emergency Circular Bulkhead
	EM14WMAINCULK	LED 14W Mains Only Circular Bulkhead
	EMDLED3WMBULK2	3W LED IP65 Maintained Emergency Bulkhead
	ACCESSORIES	
	EMBULK2FLUSH	Bulkhead Flush Kit



ESP EXIT SIGNS LED

EXIT SIGNS

	EMD2WMEXSIGNU	LED 2W Maintained Exit Sign Legend UP
	EMD2WMEXSIGNR	LED 2W Maintained Exit Sign Legend RIGHT
	EMD2WMEXSIGNL	LED 2W Maintained Exit Sign Legend LEFT
	EMD2WMEXSIGND	LED 2W Maintained Exit Sign Legend DOWN

EXIT SIGNS HANGING

B	EMD2WMEXHSIGNU	LED 2W Maintained Hanging Exit Sign Legend UP
	EMD2WMEXHSIGNR	LED 2W Maintained Hanging Exit Sign Legend RIGHT
	EMD2WMEXHSIGNL	LED 2W Maintained Hanging Exit Sign Legend LEFT
	EMD2WMEXHSIGND	LED 2W Maintained Hanging Exit Sign Legend DOWN



EMERGENCY SIGNS

	EMDLED3WMEBOXU	LED 3W Maintained Emergency Sign UP
	EMDLED3WMEBOXR	LED 3W Maintained Emergency Sign RIGHT
	EMDLED3WMEBOXL	LED 3W Maintained Emergency Sign LEFT
C	EMDLED3WMEBOXD	LED 3W Maintained Emergency Sign DOWN



ESP TWINSPOOT LED

TWINSPOOT

	EMNMIP65SPOT	LED IP65 Non Maintained Emergency Twin Spot
	EMNMIP65BSPOT	LED IP65 Non Maintained Emergency Twin Spot - Black



ESP LED DOWNLIGHTS

LED DOWNLIGHTS

	EMD3WNMDLK	LED 3W Emergency Open Lens Downlight
	EM3WNMCDLK	LED 3W Emergency Corridor Lens Downlight
	EMST3WNMDLK	LED 3W Emergency Open Lens Downlight - Self Test
D	EMST3WMSDL	LED 3W Emergency Open Corridor Lens Downlight - Self Test



Emergency Solutions for:

- Commercial
- Industry & Logistics
- Hospitality
- Leisure
- Retail
- Educational
- Office

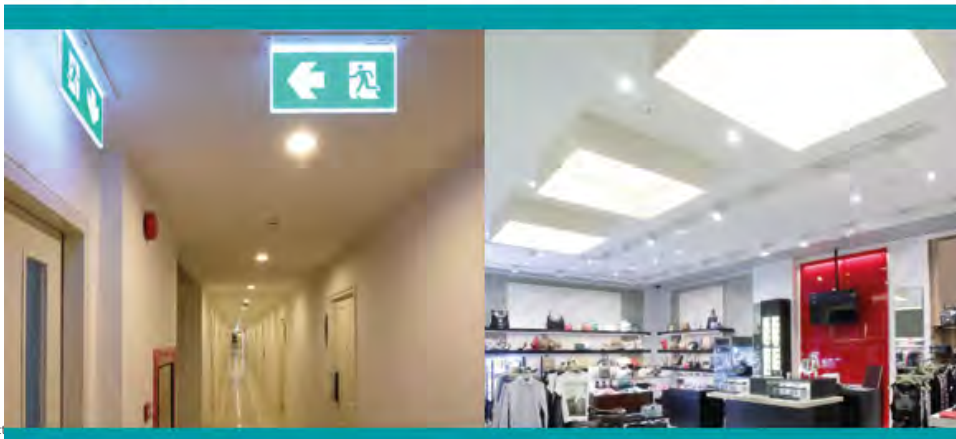

All products

YUASA EMERGENCY LIGHT BATTERIES

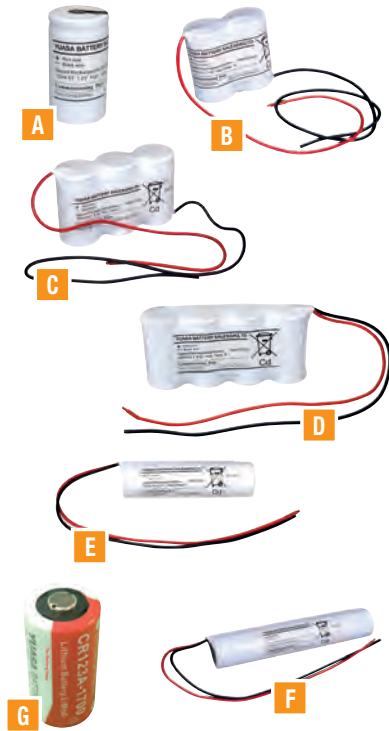

NICKEL CADMIUM

A Y1DH4 Nickel Cadmium Battery 1.2V 4Ah "D" Single Cell With Tags

NICKEL CADMIUM PACKS (SIDE BY SIDE)

B Y2DH4-OL3 Nickel Cadmium Battery 2.4V 4Ah "D" 2 Pack with Leads

C Y3DH4-OL3 Nickel Cadmium Battery 3.6V 4Ah "D" 3 Pack with Leads

D Y4DH4-OL3 Nickel Cadmium Battery 4.8V 4Ah "D" 4 Pack with Leads

Y5DH4-OL3 Nickel Cadmium Battery 6V 4Ah "D" 5 Pack with Leads

Y6DH4-OL3 Nickel Cadmium Battery 7.2V 4Ah "D" 6 Pack with Leads

NICKEL CADMIUM STICKS (END TO END)

E Y2DH4-OL4 Nickel Cadmium Battery 2.4V 4Ah "D" 2 Stick with Leads

F Y3DH4-OL4 Nickel Cadmium Battery 3.6V 4Ah "D" 3 Stick with Leads

Y4DH4-OL4 Nickel Cadmium Battery 4.8V 4Ah "D" 4 Stick with Leads

Y5DH4-OL4 Nickel Cadmium Battery 6V 4Ah "D" 5 Stick c/w Leads

Y6DH4-OL4 Nickel Cadmium Battery 7.2V 4Ah "D" 6 Stick c/w Leads

YUASA CELL BATTERIES

G 1CR123A CR123A Lithium Cylindrical cell 3V

1CR2 Lithium Cylindrical cell 3V

1AA3-6 AA Lithium cell 3.6V

YU-LITE ALARM SYSTEM BATTERY



YU-LITE LITHIUM RANGE

405050-P2/PYR 3V 4700 (mAh) single Lithium Cell. L48 x W50 x H9 (mm)

H 405050-P2/PYR/X2 3V 4700 (mAh) 2 Cell Lithium Pack. L48 X W50 x h9 (mm)

I 8AAM2-2LJ3/PYR 9.6V 2200 (mAh) Single Button Lithium Cell. L12 x W10 x H10 (mm)

J CR-1/3N/KF1/PYR 3V 170 (mAh) Single Button Lithium Cell. L12 x W10 x H10 (mm)

CR-1/3N/PYR 3V 170 (mAh) Single Button Lithium Cell. L12 x W10 x H10 (mm)

CR34615D/PYR 3V 170 (mAh) Single Button Lithium Cell. L12 x W10 x H10 (mm)



**YUASA
BATTERY**

WWW.YUASA.CO.UK



The World's Leading Battery Manufacturer



All product specifications are supplied by the manufacturer. All manufacturers reserve the right to change specification without notification.

Terms & Conditions

Catalogue

- This catalogue is a guide only. All descriptions, illustrations, drawings, dimensions, weights, measure, specifications, standards of performance or other descriptive matter are for guidance only and shall not form part of a contract. All goods are sold subject to the prices and any relevant discount ruling at the time of delivery. Our prices, discount rates and conditions of sale may be altered at any time without notice, due to manufacturer price increases or similar changes, within the life of this catalogue.

Deliveries

- We offer same day dispatch to all our customers (subject to stock availability) for orders placed before 3:00PM. In most UK destinations this means a next day delivery, any time up to 6:00PM. Timed deliveries are available on request. Orders below £250.00 will be charged at the standard rate. Orders above £250.00 are free for a standard next day delivery. Additional charges apply to timed and Saturday deliveries.
- Any discrepancies or shortages found on deliveries must be notified to us within 24 hours of receipt of the delivery.

Returns

- All products are subject to the manufacturers' conditions and policies and are beyond our control.
- Faulty products within the warranty period must be authorised by the returns department, giving a full description of the fault, date and document number relevant to the sale, before they are returned. Some items found to be faulty within the warranty period are sent back to the manufacturer and may be repaired, not replaced. If tested and found not to be faulty the product will be returned to the customer. In some cases the manufacturer will levy a charge against non-faulty items, or fault/damage caused by installation error. Any such charge, including carriage charges, will be passed on to the customer and no credit will be issued.
- Advanced replacements will be invoiced at full cost. In the case of a non-credit account customer, payment will be required before goods are dispatched.
- Non-faulty items should be authorised by us before they are returned. Detection Supplies is not obliged to take any product back. Products purchased more than 3 months previously will not be accepted back for credit. Specials will not be accepted back for credit. Products that have damaged packaging or packaging that has been modified or written on will not be accepted back for credit. Any products that we do agree to take back will be subject to a minimum re-stocking charge of 15%.
- Any returns to Detection Supplies must be recorded delivery. In the event of a missing parcel, proof of delivery will be required.

Additional 'Terms of Business' applies, a copy of which is available on request. Contact us for details.

E&OE - Although we strive to keep this document as accurate as possible, we cannot be held responsible for any errors and omissions.

SUPPLY SYNERGIES





Unit 4, Fordingbridge Business Park, Ashford Road
Fordingbridge, Hampshire, SP6 1BD

For more information or to place your order:

T 01425 658239 **F** 01425 658241

E sales@etectionsupplies.co.uk

www.etectionsupplies.co.uk